



**THE SIMULATION PLATFORM FOR
POWER ELECTRONIC SYSTEMS**

RT Box User Manual December 2024

How to Contact Plexim:

☎	+41 44 533 51 00	Phone
	+41 44 533 51 01	Fax
✉	Plexim GmbH Technoparkstrasse 1 8005 Zurich Switzerland	Mail
@	info@plexim.com	Email
	http://www.plexim.com	Web

RT Box User Manual

© 2024 by Plexim GmbH

The product described in this manual is furnished under a license agreement. The software may be used or copied only under the terms of the license agreement. No part of this manual may be photocopied or reproduced in any form without prior written consent from Plexim GmbH.

PLECS and Nanostep are a registered trademark of Plexim GmbH. MATLAB, Simulink and Simulink Coder are registered trademarks of The MathWorks, Inc. Bonjour is a registered trademark of Apple, Inc. Other product or brand names are trademarks or registered trademarks of their respective holders.

Contents

Contents	iii
What's New in Target Support Package Version 3.1	2
Major New Features	2
Enhanced Library Components	2
1 Quick Start	3
Requirements	3
Install the Target Support Package	3
Set up Zeroconf	3
Connect the RT Box	4
Upload a Model	4
Start the External Mode	5
Shutdown	6
Next Steps	6
2 Setting up the RT Box	7
Network Configuration	7
Setting the hostname	7
Using dynamically assigned IP addresses (DHCP)	8
Using static IP addresses	8
Network ports used by the RT Box	9
Firmware Update	9
Automatic Start of an Executable	10

3	RT Box Architecture	11
	Front Panel	11
	Analog Inputs	11
	Analog Outputs	14
	Digital Inputs	15
	Digital Outputs	17
	Resolver	18
	Rear Panel	20
	CAN	20
	UART	20
	Displayport	21
	Industrial Ethernet	22
	Grounding Concept	22
	Principle of Operation	23
	Execution of the Real-time Application	23
	Unsafe Math Operations	23
4	Specifications	25
	Overview	25
	Mechanical Dimensions	27
	RT Box CE	27
	RT Box 1	28
	RT Box 2	28
	RT Box 3	28
5	RT Box Coder Options	31
6	Running Simulations on the FPGA	35
	Nanostep solver	35
	FlexArray solver	36
	Enabling the FlexArray solver	36
	Prerequisites	36
	Minimizing the FlexArray solver step size	37

7 Distributed Realtime Simulation	39
Model Setup for Distributed Realtime Simulation	39
Identifying Suitable Subsystems	39
Exchanging signals between two models	40
Signal relaying	41
Time and Startup Synchronization	41
Synchronized versus Unsynchronized Simulation	42
8 Scripting	45
Establishing an XML/JSON-RPC Connection to the RT Box	45
Overview of XML-RPC Commands	46
Example Script	49
9 RT Box Target Support Library Component Reference	51
Analog In	52
Analog Out	53
CAN Receive	54
CAN Transmit	55
Data Capture	57
Digital In	58
Digital Out	59
Digital Out Override	60
EnDat Sensor	61
Incremental Encoder	64
Powerstage Protection Unit	66
Programmable Value	68
PWM Capture	69
PWM Out	70
PWM Out (Variable)	72
Quadrature Encoder Counter	80
Resolver In	82

Resolver Out 84

SFP In 85

SFP Out 86

SPI Controller 87

SPI Peripheral 90

To File 93

UDP Receive 95

UDP Send 96

Wall Clock 97

What's New in Target Support Package Version 3.1

Major New Features

- The Nanostep solver enables simulations with ultra-small simulation step sizes for controlling common power architectures. See “Running Simulations on the FPGA” (on page 35).

Enhanced Library Components

- The PWM Out block (see page 70) and the PWM Out (Variable) block (see page 72) allow to generate trigger signals for the Analog In block (see page 52) to sample a signal synchronized to a PWM carrier.
- The dead time of the PWM Out (Variable) block (see page 72) can now be modified during a realtime simulation.
- The trigger condition of the Data Capture block (see page 57) can now be set to **once at startup** to capture the data at simulation start.
- The Data Capture block (see page 57) and the Programmable Value block (see page 68) have a new parameter **Offline simulation** which makes it possible to inject or process data in the parent circuit.

Quick Start

Requirements

In order to operate your RT Box you need

- a host computer (with Microsoft Windows, Mac OS X or Linux),
- PLECS Blockset or Standalone 4.5 or newer and
- PLECS Coder.

If you have not done so yet, please download and install the latest PLECS release on your host computer.

Install the Target Support Package

Download the appropriate ZIP archive from the web page www.plexim.com/download/rt_box, extract it and move the folder PLECS_RT_Box e.g. to HOME/Documents/PLECS/CoderTargets. In PLECS, choose the entry **Preferences...** from the **File** menu (**PLECS** menu on Mac OS X) to open the PLECS Preferences dialog.

On the **Coder** tab click on the **Change** button and select the folder HOME/Documents/PLECS/CoderTargets. The RT Box Target should now be listed under **Installed targets**.

Set up Zeroconf

The RT Box uses the *Zero Configuration Networking* (Zeroconf) protocol to facilitate network communication without the aid of additional network servers. To use Zeroconf, the corresponding software components are required on your

host computer (which runs PLECS). It is also possible to use the RT Box without Zeroconf, but this requires additional steps for assigning an IP address, see “Network Configuration” (on page 7).

On Mac OS X, Zeroconf is integrated into the operating system.

On Linux, the `avahi` daemon and the `libdnssd` compatibility library must be installed. On Debian/Ubuntu Linux, the corresponding packages are named `avahi-daemon` and `libavahi-compat-libdnssd1`.

On Windows, Zeroconf is available through Apple’s Bonjour drivers, which may already be installed on your computer. Alternatively, you can install the appropriate `mDNSInstaller` package that is bundled with the Target Support Package. You find the 32-bit and 64-bit installer packages in the folder `PLECS_RT_Box/bin/win`.

Connect the RT Box

Use an Ethernet cable to connect the RT Box to your local network or – if your host computer supports Zeroconf – directly to an Ethernet port on your host computer.

Turn on the RT Box by flicking the power switch on the rear panel. The green **Power** LED at the front panel will turn on. When the RT Box has acquired a dynamic IP address from a DHCP server on the network, it will turn on the green **Ready** LED to indicate that it is ready to communicate.

Note The **Ready** LED will not turn on if you have connected the box directly with your host computer so that it uses a self-assigned IP address.

To test the network connection, open a web browser on the host computer and enter the address `http://rtbox-0123456789ab.local`, where `0123456789ab` is the MAC address of the RT Box (without colons), which you find on a sticker below the SD card slot on the back.

Upload a Model

In PLECS, choose the entry **Demo Models** from the **Window** menu to open the PLECS Demo Model Library. Open the demo model **Basic Topologies / Boost converter** and save it e.g. as `HOME/Documents/PLECS/Boost-RT.plecs`.

In order to generate code for the complete model, open the Coder Options dialog by choosing the entry **Coder options...** from the **Coder** menu. In the **General** tab set the **Discretization step size** parameter to e.g. 1e-5.

Now select the **Target** tab and switch the **Target** selector from **Generic** to either PLECS RT Box 1, PLECS RT Box 2 or PLECS RT Box 3 depending on which target the model should later run. If this option is not available, the RT Box Support Package has not been installed correctly (see “Install the Target Support Package” on page 3).

In the **Target device** field, enter the address of your RT Box. If your host computer supports Zeroconf, a button marked ... appears next to this field. A click on this button opens a browser that shows the RT Boxes that are visible in the network.

Click on the **Build** button at the bottom of the Coder Options dialog to start the build process. This will generate the C code for the model, compile it and upload it to the RT Box. After the successful upload, the blue **Running** LED on the front panel of the RT Box will turn on to indicate that the real-time application is running.

Start the External Mode

Select the **External Mode** tab of the Coder Options dialog and click on the **Connect** button. Set the **Number of samples** parameter to e.g. 200 and click on the **Activate autotriggering** button. PLECS will now capture the real-time signals of the Ammeter and Voltmeter in the model running on the RT Box and display them on the Scope in your PLECS model.

You can synchronize the data capture to a specific trigger event. To do so, set the **Trigger channel** selector from **Off** to the desired signal. The Scope will now show a small square indicating the trigger level and delay. If the level or delay are outside the current axes limits, a small triangle will be shown instead. Drag the trigger icon to change the trigger level; drag it with the left mouse-button pressed to change the trigger delay. Both parameters can also be set in the External Mode dialog.

Note While a trigger channel is active, the Scope signals are only updated when a trigger event is detected.

While the PLECS model is connected to the RT Box, the model is locked against modifications. To disconnect from the RT Box, click on the **Disconnect** button or close the Coder Options dialog.

Shutdown

To turn off the RT Box, simply flip the power switch on the rear panel.

Next Steps

To connect the real-time application with real-world I/O signals, use the blocks from the **PLECS RT Box** library in the PLECS Library Browser. For instance, to use a digital input channel as the gate signal for the FET, replace the Pulse Generator with a Digital In block (see page 58). To feed the current and/or voltage measurement back to an external controller via an analog output channel, use an Analog Out block (see page 53) and connect it to the desired meter.

Setting up the RT Box

Network Configuration

Communication with the RT Box is done via Ethernet. The box is identified either by its IP address or by a unique hostname. The RT Box supports *Zero Configuration Networking* (Zeroconf) to allow identifying the box by its hostname without any additional network servers (see “Set up Zeroconf” on page 3).

Three networking scenarios are supported by the RT Box:

- **Dynamically assigned IP addresses:** The RT Box is connected to a larger network and receives an IP address from an external DHCP server. Name resolution is done by an external DNS server or optionally by using Zeroconf.
- **Static IP address:** A fixed IP address is assigned to the RT Box. The box can be accessed by its IP address. Name resolution is done by an external DNS server or optionally by using Zeroconf.
- **Self-assigned IP address:** The RT Box is connected directly to a PC with no additional network infrastructure. Both the RT Box and the PC use automatically assigned IP addresses. Address assigning and name resolution is done by Zeroconf, the installation of a Zeroconf driver is mandatory.

Setting the hostname

Since the IP address of the RT Box is typically not known it is more convenient to access the box by its hostname. By default the hostname is set to the MAC address (without colons) with the prefix `rtbox-`, for example `rtbox-20b0f70361c2`. The MAC address is printed on a sticker below the SD card slot on the backside of the RT Box. A custom hostname can be set by creating a text file named `hostname` in the directory `/config/etc` on the SD card of the RT Box. The file should contain a single line with the custom hostname.

Using dynamically assigned IP addresses (DHCP)

By default the RT Box is configured to use a dynamically assigned IP address from a DHCP server. No additional setup is necessary for this scenario.

After the box has been switched on the green *Ready* LED will turn on when the box has acquired an IP address from the DHCP server and is ready for communication.

If the box was previously configured with a static IP address it can be reconfigured to use dynamic address by removing the file `/config/etc/network/interfaces` from the SD card.

Using static IP addresses

Follow these steps for configuring the RT Box using static IP addresses:

- 1** Choose a suitable private IP subnet. For example, enter `192.168.0.3` for the RT Box and choose `192.168.0.2` for the host computer.
- 2** Create a text file with the following structure with your specific addresses (the parameters):

```
auto lo
iface lo inet loopback
auto eth0
# IPv4 address: all parameters except for 'address' and 'netmask' are optional
iface eth0 inet static
    address 192.168.0.3
    netmask 255.255.255.0
    network 192.168.0.0
broadcast 192.168.0.255
gateway 192.168.0.1
```

The file must be named `interfaces` and be placed in the directory `/config/etc/network` on the SD card of the RT Box.

- 3** Plug the ethernet cable of the RT Box to either an ethernet port or an ethernet adapter of the host computer and boot the RT Box.
- 4** For Windows:

Open the “Network and Sharing Center” in the Windows Control Panel and click on the appropriate connection.

In the “Local Area Connection x Status” window, click on **Properties**.

In the “Local Area Connection x Properties” window, double-click on **Internet Protocol Version 4 (TCP/IPv4)**.

In the “Internet Protocol Version 4 (TCP/IPv4) Properties” window, configure the static IP address of the host computer. For example, enter 192.168.0.2 as the “IP address” and 255.255.255.0 as the “Subnet mask”.

5 For Mac:

“Open Network Preferences” and select the appropriate interface with a new “Service Name”.

“Manually” configure the IPv4 of the host computer. For example, enter 192.168.0.2 as the “IP address” and 255.255.255.0 as the “Subnet mask”.

6 The RT Box should now be listed when clicking the Browse RT Boxes button. The RT Box can be targeted by entering the chosen static IP address of the RT Box, for example, enter 192.168.0.3 or the hostname `rtbox-xyz.local` as the *Target Device* in the Coder Options dialog.

Network ports used by the RT Box

If the RT Box is to be operated behind a firewall the following TCP ports need to be opened to be able access the RT Box through the firewall:

TCP Port	Purpose
80	Web interface
9998	RPC
9999	External mode

Additionally all UDP ports used in UDP Send or UDP Receive blocks may have to be forwarded.

Firmware Update

The firmware of the RT Box is stored on a SD Card which is accessible on the back side of the box. The version of the installed firmware is displayed in the **Info** tab in the RT Box web interface.

Follow these steps for updating the firmware:

- 1 Make sure that the latest version of the target support package is installed on your PC. The target support package is available from the Plexim website.
- 2 Turn off the RT Box. Remove the SD Card from the slot on the back of the box by pushing it in.
- 3 Put the card into an SD card reader connected to your PC.
- 4 Locate the new firmware: Open the directory containing the target support package, then open the folder PLECS_RT_Box/firmware. It contains a sub-directory **versionnumber**, e.g. 1.2.0, with another sub-directory **rtbox1** (for RT Box 1 and CE) and **rtbox2** (for RT Box 2 and 3). The firmware consists of three files: **image.ub**, **BOOT.BIN** and **uboot.env**.
- 5 Copy the files **image.ub**, **BOOT.BIN** and **uboot.env** to the root directory of the SD card.
- 6 Eject the SD card and remove it from the card reader.
- 7 Place the SD card back into the slot on the back of the RT Box.
- 8 Turn on the box and reload the web interface of the RT Box in your web browser. The new firmware version should be displayed in the **Info** tab of the RT Box Web Interface.

Automatic Start of an Executable

It is possible to automatically run an executable directly after the startup of the RT Box. This option is useful if an RT Box should always run the same model or if no connection to a host PC is available.

Follow these steps to configure the box for this purpose:

- 1 Leave the **target device** field of the **Target** tab in the PLECS Coder options empty and generate code.
- 2 Open the output directory that is specified in the **General** tab of the PLECS Coder options.
- 3 Rename the file *modelName.elf* to *autostart.elf* and copy it to the root directory of the SD card which also contains the RT Box firmware.
- 4 Reboot the RT Box with the same SD card. The model will start after the RT Box has booted up.

RT Box Architecture

This chapter describes the hardware architecture of the RT Box 1, 2 and 3. Most of the following properties are common to all versions of the RT Box. Differences between versions are specifically mentioned in the following sections.

Front Panel

The front panel of the RT Box contains connectors for the analog and digital inputs and outputs (I/Os). For RT Box 1 and 2 there are four of these connectors whereas the RT Box 3 has eight. The I/Os need to be connected by the user to the device-under-test (DUT). If the RT Box is employed for HIL simulations, the DUT is the real control hardware and the RT Box emulates the plant. If the RT Box is used for rapid control prototyping, the DUT is the real plant controlled by the RT Box.

All I/O connectors are 37 pin normal-density D subminiature (D-Sub) connectors. Male connectors are used for inputs while female ones are used for outputs.

In addition, the front panel of the RT Box 1 contains 4 LEDs to indicate the status of the box. For the RT Box 2 and 3 the status of the box is shown in an interactive display.

Analog Inputs

The RT Box 1 and 2 provide 16 analog input channels the RT Box 3 provides 32 thereof. The input voltage range can be set for all channels together to either $\pm 10\text{ V}$ or $\pm 5\text{ V}$. Each channel can be individually configured for differential or single-ended measurement.

The analog-to-digital converters (ADCs) inside the RT Box are specified for a maximum sampling rate of 2 MSPS with no-cycle latency for the RT Box 1 and a maximum sampling rate of 5 MSPS with 1 cycle latency for the RT Box 2 and 3.

As the firmware of the RT Box currently limits the cycle time to a minimum of 1 μ s, a sampling rate of up to 1 MSPS can be realized when the ADC measurements are synchronized to the simulation step (default). Higher sampling rates are possible by configuring channel specific software or hardware triggers, which enables continuous ADC sampling. Linear interpolation of ADC values in hardware is then used for even finer resolution, as the analog inputs are still transferred once per simulation step only.

The analog inputs play an important role when the RT Box is used for rapid control prototyping. To allow instantaneous sampling of the input signals, the analog inputs do not have internal anti-aliasing filters. If the bandwidth of the input signal shall be limited, such filters must be added externally.

Differential measurement

The analog inputs are equipped for fully differential measurement. The measured voltage is the difference between the positive and the negative input. The full-scale differential input range is ± 10 V or ± 5 V, depending on the configuration.

A ground connection between the DUT and the RT Box is required even in differential mode, because the inputs cannot float freely with respect to GND. For linear operation, the input voltages referenced to GND shall not exceed ± 10.8 V. As a consequence, the acceptable common mode voltage range is ± 5.8 V (for ± 10 V operation) and ± 8.3 V (for ± 5 V operation).

Single-ended measurement

To configure an input channel for single-ended measurement, only the positive input is used for signal measurement while the corresponding negative input is clamped to GND. The full-scale input voltage range is either ± 10 V or ± 5 V, depending on the configuration.

Analog Input Connector

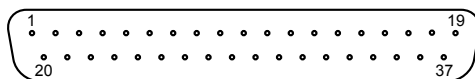

37 pin male D-Sub (front view)

Pinout of the analog input connector. *The value in brackets (x) specifies the channel number for the second analog input connector of the RT Box 3.

Pin	Description*	Pin	Description
1	Analog input 0 (16) positive	20	Analog input 0 (16) negative
2	Analog input 1 (17) positive	21	Analog input 1 (17) negative
3	Analog input 2 (18) positive	22	Analog input 2 (18) negative
4	Analog input 3 (19) positive	23	Analog input 3 (19) negative
5	Analog input 4 (20) positive	24	Analog input 4 (20) negative
6	Analog input 5 (21) positive	25	Analog input 5 (21) negative
7	Analog input 6 (22) positive	26	Analog input 6 (22) negative
8	Analog input 7 (23) positive	27	Analog input 7 (23) negative
9	Analog input 8 (24) positive	28	Analog input 8 (24) negative
10	Analog input 9 (25) positive	29	Analog input 9 (25) negative
11	Analog input 10 (26) positive	30	Analog input 10 (26) negative
12	Analog input 11 (27) positive	31	Analog input 11 (27) negative
13	Analog input 12 (28) positive	32	Analog input 12 (28) negative
14	Analog input 13 (29) positive	33	Analog input 13 (29) negative
15	Analog input 14 (30) positive	34	Analog input 14 (30) negative
16	Analog input 15 (31) positive	35	Analog input 15 (31) negative
17	n/c	36	n/c
18	n/c	37	GND

(contd.) Pinout of the analog input connector. *The value in brackets (x) specifies the channel number for the second analog input connector of the RT Box 3.

Pin	Description*	Pin	Description
19	n/c	Shield	PE

Note For the RT Box CE, analog input positive-negative channel pair from number 8 to 15 are not connected (n/c).

Analog Outputs

The 16 analog output channels of the RT Box are heavily used for HIL simulations. The analog outputs provide the voltage signals from sensors inside the simulated plant and need to be connected to the analog inputs of the controller.

The full-scale voltage range of the outputs can be set to $\pm 10\text{ V}$, $0 \dots 10\text{ V}$, $\pm 5\text{ V}$ and $0 \dots 5\text{ V}$.

For testing purposes, the analog outputs can be connected with the analog inputs of the same or a different RT Box using a 37 pin D-Sub extension cable.

Analog Output Connector

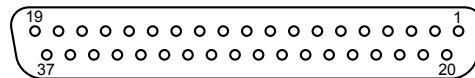

37 pin female D-Sub (front view)

Pinout of the analog output connector. *The value in brackets (x) specifies the channel number for the second analog output connector of the RT Box 3.

Pin	Description*	Pin	Description
1	Analog output 0 (16)	20	GND
2	Analog output 1 (17)	21	GND
3	Analog output 2 (18)	22	GND
4	Analog output 3 (19)	23	GND
5	Analog output 4 (20)	24	GND
6	Analog output 5 (21)	25	GND
7	Analog output 6 (22)	26	GND
8	Analog output 7 (23)	27	GND
9	Analog output 8 (24)	28	GND
10	Analog output 9 (25)	29	GND
11	Analog output 10 (26)	30	GND
12	Analog output 11 (27)	31	GND
13	Analog output 12 (28)	32	GND
14	Analog output 13 (29)	33	GND
15	Analog output 14 (30)	34	GND
16	Analog output 15 (31)	35	GND
17	n/c	36	n/c
18	n/c	37	GND
19	n/c	Shield	PE

Digital Inputs

Active bus hold circuitry holds unused or floating data inputs at a valid logic level. If a specific logic level is required for high-impedance inputs, pull-down or pull-up resistors must be connected externally.

Digital Input Connector

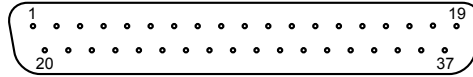

37 pin male D-Sub (front view)

Pinout of the digital input connector. *The value in brackets (x) specifies the channel number for the second digital input connector of the RT Box 3.

Pin	Description	Pin	Description
1	Digital input 0 (32)	20	Digital input 1 (33)
2	Digital input 2 (34)	21	Digital input 3 (35)
3	Digital input 4 (36)	22	Digital input 5 (37)
4	Digital input 6 (38)	23	Digital input 7 (39)
5	GND	24	Digital input 8 (40)
6	Digital input 9 (41)	25	Digital input 10 (42)
7	Digital input 11 (43)	26	Digital input 12 (44)
8	Digital input 13 (45)	27	Digital input 14 (46)
9	Digital input 15 (47)	28	GND
10	Digital input 16 (48)	29	Digital input 17 (49)
11	Digital input 18 (50)	30	Digital input 19 (51)
12	Digital input 20 (52)	31	Digital input 21 (53)
13	Digital input 22 (54)	32	Digital input 23 (55)
14	GND	33	Digital input 24 (56)
15	Digital input 25 (57)	34	Digital input 26 (58)
16	Digital input 27 (59)	35	Digital input 28 (60)
17	Digital input 29 (61)	36	Digital input 30 (62)
18	Digital input 31 (63)	37	GND

(contd.) Pinout of the digital input connector. *The value in brackets (x) specifies the channel number for the second digital input connector of the RT Box 3.

Pin	Description	Pin	Description
19	5 V, 1.5 A max.	Shield	PE

Digital Outputs

Digital Output Connector

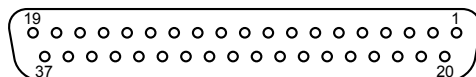

37 pin female D-Sub (front view)

Pinout of the digital output connector. *The value in brackets (x) specifies the channel number for the second digital output connector of the RT Box 3.

Pin	Description	Pin	Description
1	Digital output 0 (32)	20	Digital output 1 (33)
2	Digital output 2 (34)	21	Digital output 3 (35)
3	Digital output 4 (36)	22	Digital output 5 (37)
4	Digital output 6 (38)	23	Digital output 7 (39)
5	GND	24	Digital output 8 (40)
6	Digital output 9 (41)	25	Digital output 10 (42)
7	Digital output 11 (43)	26	Digital output 12 (44)
8	Digital output 13 (45)	27	Digital output 14 (46)
9	Digital output 15 (47)	28	GND
10	Digital output 16 (48)	29	Digital output 17 (49)
11	Digital output 18 (50)	30	Digital output 19 (51)

(contd.) Pinout of the digital output connector. *The value in brackets (x) specifies the channel number for the second digital output connector of the RT Box 3.

Pin	Description	Pin	Description
12	Digital output 20 (52)	31	Digital output 21 (53)
13	Digital output 22 (54)	32	Digital output 23 (55)
14	GND	33	Digital output 24 (56)
15	Digital output 25 (57)	34	Digital output 26 (58)
16	Digital output 27 (59)	35	Digital output 28 (60)
17	Digital output 29 (61)	36	Digital output 30 (62)
18	Digital output 31 (63)	37	GND
19	n/c	Shield	PE

Resolver

The RT Box 2 and 3 provide a resolver interface that can be used for Hardware-in-the-loop (HIL) and Rapid Control Prototyping (RCP) applications.

Resolver In Connector (RCP)

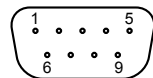

9 pin male D-Sub (front view)

Pinout of Resolver In connector

Pin	Description
1	GND
2	+COSIN
3	+SININ

Pinout of Resolver In connector

Pin	Description
4	+EXCOUT
5	GND
6	-COSIN
7	-SININ
8	GND
9	-EXCOUT

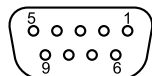
Resolver Out Connector (HIL)

9 pin female D-Sub (front view)

Pinout of Resolver Out connector

Pin	Description
1	GND
2	+COSOUT
3	+SINOUT
4	+EXCIN
5	GND
6	-COSOUT
7	-SINOUT
8	GND
9	-EXCIN

Rear Panel

CAN

The CAN connector is available on RT Box 2 and 3 and hardware revision 1.2 of the RT Box 1.

CAN Connector

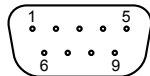

9 pin male D-Sub (front view)

Pinout of CAN connector

Pin	Description
1	n/c
2	CAN_L channel 1
3	GND
4	CAN_L channel 2
5	n/c
6	n/c
7	CAN_H channel 1
8	CAN_H channel 2
9	n/c

The CAN connector is electrically isolated from the rest of the RT Box.

UART

The UART Interface is only available on the RT Box 2 and 3.

RS-232/422/485 Connector

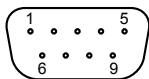

9 pin male D-Sub (front view)

Pinout of RS-232/422/485 connector

Pin	RS-232	RS-422	RS-485
1	RXD channel 2	Rx+ channel 2	n/c
2	RXD channel 1	Rx+ channel 1	n/c
3	TXD channel 1	Tx+ channel 1	TRx+ channel 1
4	TXD channel 2	Tx+ channel 2	TRx+ channel 2
5	GND	GND	GND
6	RTS channel 2	Tx- channel 2	TRx- channel 2
7	RTS channel 1	Tx- channel 1	TRx- channel 1
8	CTS channel 1	Rx- channel 1	n/c
9	CTS channel 2	Rx- channel 2	n/c

The RS-232/422/485 connector is electrically isolated from the rest of the RT Box.

Displayport

A displayport connector is only available on the RT Box 2 and 3. There is currently no software implementation in the RT Box target support package for this interface.

Displayport Connector



Displayport connector (front view)

Industrial Ethernet

Two Industrial Ethernet ports are available on the RT Box 2 and 3. The EtherCAT fieldbus interface is available via this port on RT Box 2 and RT Box 3 with hardware revision 1.2 and newer.

Industrial Ethernet Connector

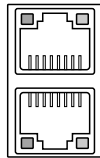

Industrial Ethernet connector (front view)

Grounding Concept

Inside the RT Box, signal Ground (GND) and Protective Earth (PE) are not connected directly. Instead, GND and PE are loosely coupled by means of a high impedance RC network, consisting of a $1\text{ M}\Omega$ resistor, a $1\ \mu\text{F}$ capacitor and a 5V zener diode (SMAJ5.0CA), all connected in parallel. This configuration avoids ground loops that might otherwise occur if the device-under-test (DUT) used single-ended analog measurement and provided a low-impedance connection between GND and PE.

As the communication lines of both the Ethernet port and the SFP+ modules are AC coupled, multiple RT Boxes can be connected with each other and to a host computer without creating ground loops. At the RT Box, the shields of those lines are connected to PE. The service port is also referenced to PE and isolated from GND of the RT Box.

At the rear panel, only the SD card slot and the USB A receptacle are referenced to GND of the RT Box. Mass storage devices such as SD cards and USB memory sticks usually do not have a PE connection, so they can be used at these ports without creating ground loops. However, care should be taken when using externally powered USB devices with a PE connection, such as printers.

The CAN connector (only available on certain versions of the RT Box) and the RS-232/422/485 connector (only available on RT Box 2/3) are electrically isolated from the rest of the RT Box.

Principle of Operation

The basic building blocks of the RT Box are shown in the figure below.

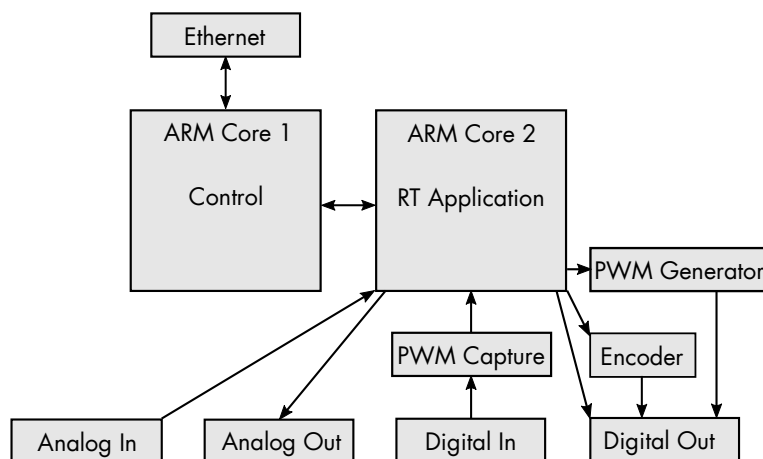

RT Box Overview

The RT Box uses two ARM cores. The first core is responsible for communication, both directly with PLECS or through the web interface of the RT Box.

The second ARM core is dedicated to the real-time application. It has direct access to the different peripheral blocks. Digital Out signals can be set either directly or through the PWM Generator or Encoder unit. Digital Inputs can be sampled by the PWM capture block which allows for high accuracy duty cycle measurement. The Digital Inputs can also be read directly.

Execution of the Real-time Application

After the real-time application has been initialized, its step function is called in fixed periodic intervals, t_{Cycle} . The cycle time must be chosen large enough to ensure that the step function is always executed completely before a new cycle is started.

Unsafe Math Operations

The C standard specifies that the result of the divide operators "/" or "%" is undefined if the second operand is zero. PLECS does not add extra checks when

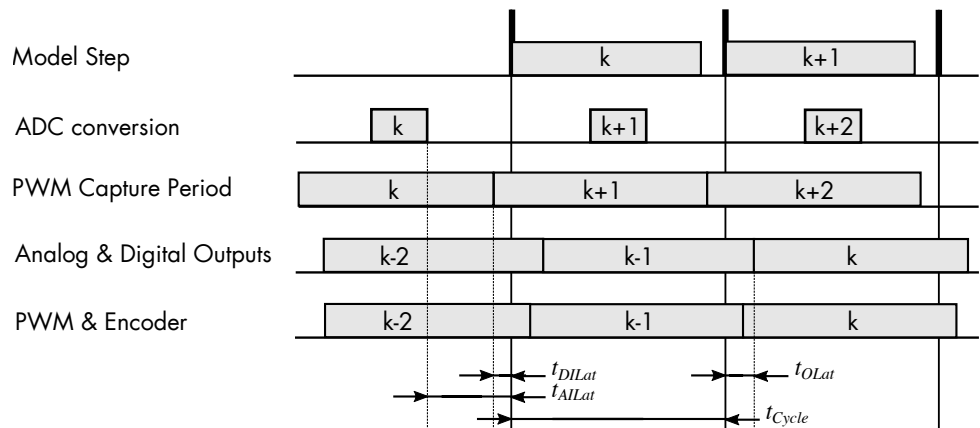

Input / output timing

generating code which uses a divide operator. For this reason it is the responsibility of the model creator to ensure that a division-by-zero condition does not occur.

In most cases, a floating point division-by-zero results in a floating point value of *NaN* (Not a Number) or $\pm\infty$, whereas an integer division-by-zero results in immediate program termination. However, this behavior should not be relied upon.

The same applies to other math operations that are undefined, e.g. $\tan(\pi/2)$, $\text{asin}(2)$ etc.

Specifications

Overview

		RT Box CE	RT Box 1	RT Box 2	RT Box 3
Processor	Simulation Cores	1 x 1 GHz		3 x 1.5 GHz	
	Xilinx Zynq	Z-7030		ZU9EG	
Analog inputs	Channels	8	16		32
	Resolution	16 bit simultaneous sampling			
	Voltage ranges	-10 ... 10 V -5 ... 5 V			
	Input type	Differential			
	Max. sample rate	2 Msps		5 Msps	3 Msps
	Input impedance	1 M Ω , 24 pF			
	Connector	D-Sub 37 pin male			
Analog outputs	Channels	16			32
	Resolution	16 bit simultaneous update			
	Voltage ranges	-10 ... 10 V 0 ... 10 V -5 ... 5 V 0 ... 5 V			

	Sample rate	2 Msps		5 Msps	
	Output impedance	0 Ω			
	Max. output current	10 mA			
	Connector	D-Sub 37 pin female			
Digital inputs	Channels	32		64	
	Logic levels	3.3 V (5 V tolerant)			
	High-level input	min. 2 V			
	Low-level input	max. 0.8 V			
	Configurable input impedance	high or 10 k Ω against 3.3 V or GND			
	Connector	D-Sub 37 pin male			
Digital outputs	Channels	32		64	
	Logic levels	3.3 V and 5 V			
	Output impedance	220 Ω			
	Output current	\leq 10 mA			
	Connector	D-Sub 37 pin female			
Resolver	Input/Output	-/-		1/1	2/2
	Connector	D-Sub 9 pin male/fem.			
I/O Protection	Short-circuit	Permanent			
	Overvoltage	-24 ... 24 V			
Connectivity	Gigabit Ethernet	1		2	
	SFP+ (6.25 Gbps/lane)	-	4	8	
	Ind. Ethernet	-		2	
	CAN bus	2			

	RS 232/422/485	-	2		
	USB device	USB 2.0 High-Speed, type A	USB 3.0 Super-Speed, type A		
	Display Port	-	1		
Storage	Internal SSD	-	480 GB		
	Firmware	SD card			
Power supply	Internal	100 ... 240 Vac			
		50 ... 60 Hz			
		30 VA	50 VA	65 VA	100 VA
Size	Depth x Width (mm x mm)	225 x 165	310 x 250		
	Height (mm)	55	100		145

Table 4.1: Technical Specifications of RT Box CE, 1, 2 and 3

Mechanical Dimensions

RT Box CE

The four 37 pin D-Sub connectors on the front panel are displaced 19.05 mm (0.75 inch) vertically and 84 mm (3.3 inch) horizontally.

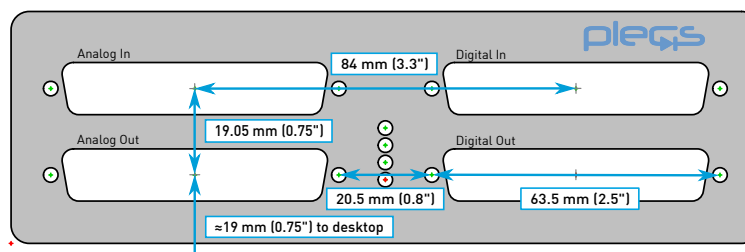

Mechanical dimensions of the front panel of the RT Box CE

RT Box 1

The four 37 pin D-Sub connectors on the front panel are displaced 19.05 mm (0.75 inch) vertically and 84 mm (3.3 inch) horizontally.

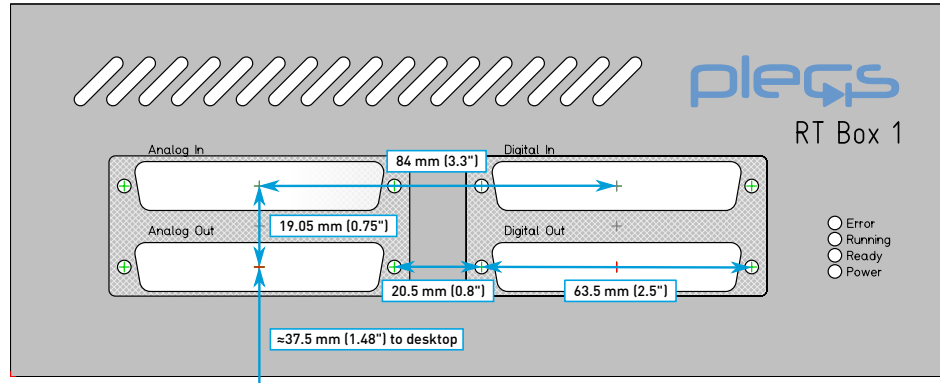

Mechanical dimensions of the front panel of the RT Box 1

RT Box 2

The four 37 pin D-Sub connectors on the front panel for digital and analog in-/outputs are displaced 84 mm (3.3 inch) horizontally and 19.05 mm (0.75 inch) vertically. The resolver connectors have the same vertical displacement as the analog and digital in-/outputs and a horizontal distance of 64.5 mm to the digital in- and outputs.

RT Box 3

The eight 37 pin D-Sub connectors on the front panel for digital and analog in-/outputs are displaced 84 mm (3.3 inch) horizontally and 19.05 mm (0.75 inch) / 23.15 mm (0.91 inch) vertically. The resolver connectors have the same vertical displacements as the analog and digital in-/outputs and a horizontal distance of 64.5 mm to the digital in- and outputs.

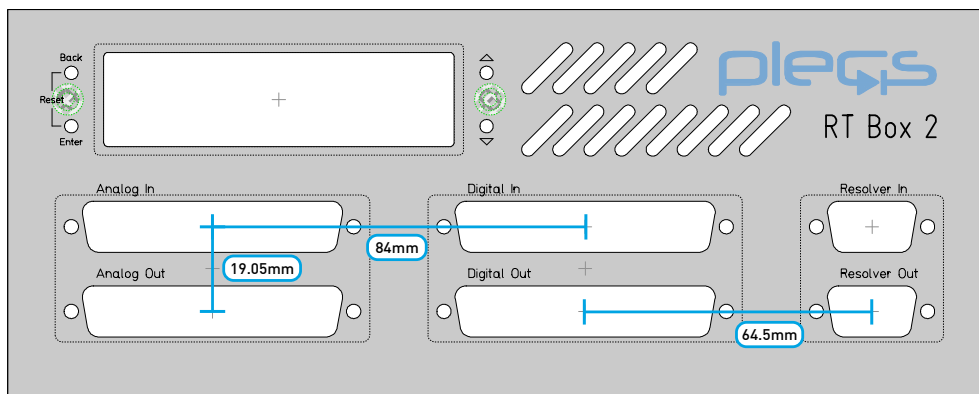

Mechanical dimensions of the front panel of the RT Box 2

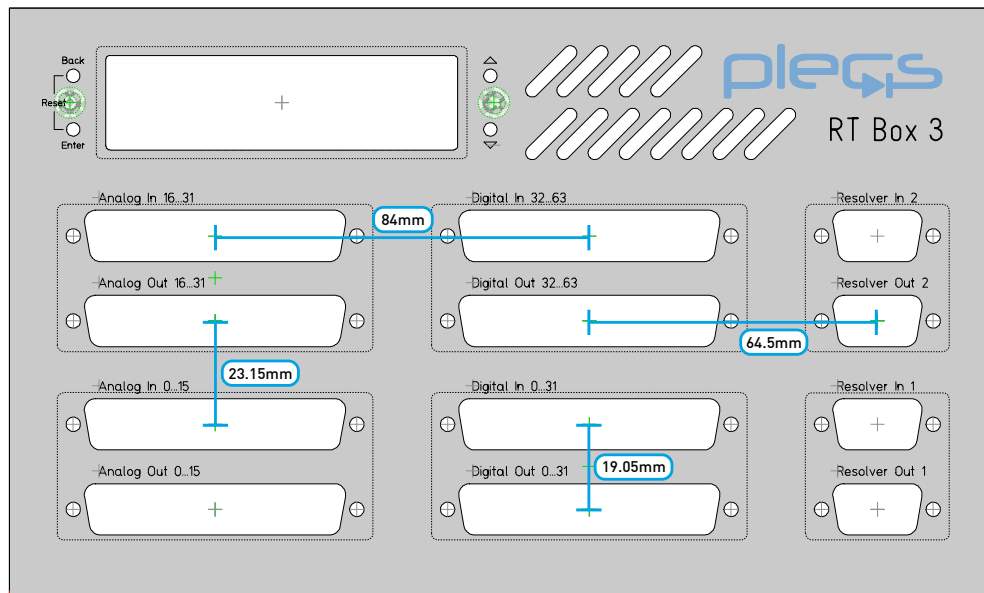

Mechanical dimensions of the front panel of the RT Box 3

RT Box Coder Options

The **Target** page contains code generation options which are specific to the PLECS RT Box.

General

Analog input voltage range The allowed voltage range for analog input signals. The specified range is discretized with a resolution of 16 bit. For best results the smallest matching range should be selected.

Analog output voltage range The voltage range for analog output signals. The specified range is discretized with a resolution of 16 bit. For best results the smallest matching range should be selected.

Digital output voltage level The voltage level for all digital outputs of the RT Box. Possible values are 3.3 V and 5 V.

Analog input sampling / Sampling delay The delay (in seconds) between the start of the simulation step and the sampling of the analog inputs for the next simulation step. If a sampling delay of 0 is specified, sampling for the next simulation step is done at the beginning of the current simulation step (corresponding to the maximum latency). To sample the analog inputs as late as possible, select **Minimize latency**. Minimum latency is usually desirable unless sampling must be synchronized to, for example, the peaks of the PWM carrier. Alternatively, the Analog In block allows to configure individual software or hardware triggers.

Overrun limit The maximum number of consecutive overruns that may occur before the simulation is aborted. Increasing this parameter allows the simulation to continue in certain conditions where the calculation time exceeds the model step size for a short period of time, e.g. when sending the first trigger command in external mode.

Simulation mode When set to **HIL**, the default value, the RT Box behaves as discussed in chapter “Principle of Operation” (on page 23): The outputs of the RT Box are updated at the start of the next simulation step. In rapid control prototyping applications, this can lead to undesirable latency. When switching to **RCP**, the outputs of the RT Box are updated immediately after the calculation for the simulation step is completed (at the expense of less time available for the calculation). **RCP** mode cannot be used when multitasking is enabled.

Enable external mode This setting adds code to use the external mode on the RT Box. Code size and memory consumption are slightly increased when the external mode is enabled.

Enable XCP XCP is the Universal Measurement and Calibration Protocol published by the Association for Standardisation of Automation and Measuring Systems (www.asam.net). RT Box 2 and RT Box 3 support the XCP protocol version 1.5 over a UDP network connection. The RT Box acts as an XCP slave device. It can be accessed on UDP port 5555.

When enabled, all signals to scopes, XY plots and display blocks are available as DAQ measurements. All tuneable parameters can be modified using STIM packets. An A2L file is generated in the output directory of the code generation process for import into an XCP master (e.g. CANape from Vector Informatik GmbH).

XCP slave identity This options specifies how the RT Box is identified in the generated A2L file. When set to **Use target device**, the name of the box is taken from the Target device input field. When set to **Specify host name** or **Specify IP address**, the host name or IP address of the RT Box can be explicitly specified. For use with CANape it seems to be necessary to specify the IP address explicitly.

Interconnect

These options allow to synchronize multiple connected RT Boxes. Please also read section “Time and Startup Synchronization” (on page 41).

Primary box for startup/clock Specifies on which SFP port the primary RT Box is connected. For the top level primary box or for standalone boxes this option must be set to `Self`.

Synchronize startup with SFP x Enables startup synchronization on the given SFP port. Primary boxes must enable startup synchronization on all ports to which a secondary box is connected. Secondary boxes must enable startup synchronization on the port to which the primary box is connected.

Use clock from primary box Enables simulation time step synchronization. The SFP port to which the primary RT Box is connected must be specified in option **Primary box for startup/clock**. No settings are necessary on the primary RT Box.

CAN

These options allow to set up the CAN interfaces of the RT Box.

Enable CANx Enables or disables a CAN interface. If a CAN interface is enabled and configured to use digital IO pins, these pins cannot be used for other purposes (e.g. PWM generation or PWM capturing).

Baud rate The baud rate that is used on the connected CAN bus. All devices on a CAN bus must be configured to use the same baud rate.

TX/RX pin Specifies which IOs to use for CAN communication. Each CAN channel requires one input and one output pin. Select 'Internal CAN interface' for the in-built CAN interface on the back of some RT Box models (see section "CAN" (on page 20)). This option is only available with RT Box 1. RT Box 2 and 3 always use the internal CAN interface.

CANx error recovery delay [ms] If too many errors occur on the CAN bus, the CAN bus switches to a *bus-off* state. If this parameter is set to a non-zero value, automatic recovery is activated. The value specifies the time in milliseconds after which the recovery should be started. A value of 0 disables automatic recovery.

Running Simulations on the FPGA

Depending on the RT Box model, two distinct methods are available for executing an electrical model or the time-critical parts of it on the FPGA.

The **Nanostep solver** enables simulations with ultra-small simulation step sizes for certain parts of an electrical model.

The **FlexArray** solver allows to simulate complete electrical systems on the FPGA, delivering high update rates and low latency. Both solvers run independently and can even be combined on RT Box 2 and 3.

Nanostep solver

The Nanostep solver uses ultra-small simulation step sizes for controlling common power architectures, supporting MHz-level switching frequencies. Each simulation step includes sampling, calculation, and diode switch state determination. On RT Box 2 and 3 the simulation time step is just 4 ns, on RT Box 1 and CE it is 7.5 ns.

With the Nanostep solver, only the time-critical part of a circuit is calculated with nanostep resolution. The remaining part of the system is calculated either on the CPU or the FlexArray solver.

The power modules supported by the Nanostep solver can be found in the 'Nanostep' category of the PLECS components library. At least one Nanostep power module must be present in the model to use the Nanostep solver. To run the power module on a Nanostep solver, the **Configuration** parameter of the power module must be set to 'Nanostep'.

The top line of the display of an RT Box 2 or 3 indicates an active Nanostep solver by displaying the step size of the Nanostep solver before the DAC update rate, e.g. „4 ns / 250 ns”. An active Nanostep solver is also indicated in the web interface of the RT Box.

The number of Nanostep power modules that can be simulated within one model is limited. Each Nanostep power module is associated with a weight (a simple dual active bridge, for example, has weight of 1, a full-bridge resonant converter a weight of 3 - see the documentation of the respective power modules). RT Box 2 and 3 allow the simulation of Nanostep power modules with a total weight sum of 6, for RT Box CE and 1 the total weight sum is limited to 3.

FlexArray solver

RT Box 2 and RT Box 3 allow to run simulations on the FPGA using the FlexArray solver. Depending on the complexity of the model, this allows step sizes below 400 ns.

Only the electrical domain of a PLECS model can be run on the FPGA. This usually comprises PWM Capture (see page 69) blocks, an electrical circuit with power modules, and meters that are connected to AnalogOut (see page 53) blocks. The control part of the model will always be simulated on the CPU.

When a simulation is running using the FlexArray solver, the analog outputs of the RT Box are updated after each FPGA step.

Enabling the FlexArray solver

Whether an electrical circuit is simulated on the CPU or the FPGA is controlled by the **Electrical Model Settings** block. Place the block on the schematic and connect it to the electrical circuit that should be simulated on the FPGA. The **Target** parameter controls whether the code for this circuit is generated for the CPU or the FPGA.

Prerequisites

Code generation for the FlexArray solver is only supported for circuits based on Power Modules. Additionally, the following discrete Power Semiconductors and Switches are supported:

- Diode

- Thyristor
- Triac
- Switch
- Double Switch
- Triple Switch
- Breaker

The electrical circuit that is to be simulated on the FPGA must not contain more than 16 Power Modules. They must be connected directly to PWM capture blocks. On an RT Box 3, the PWM Capture blocks connected to the Power Modules must use the lower 32 digital input channels.

The FlexArray solver uses a non-ideal switch model. Once a circuit is configured for FPGA, all switches use the non-ideal switch model automatically, regardless of their **Switch model** parameter.

To facilitate updates of the analog outputs with the full rate of FPGA step sizes, Meters (e.g. Voltmeters, Ammeters) must be connected directly to AnalogOut blocks. Exemptions are additional gain or offset blocks in the signal path.

Minimizing the FlexArray solver step size

The calculation time of one simulation step of the FlexArray solver depends on the complexity of the model. It does not vary from one step to the next.

The FlexArray solver step size is automatically selected as the minimum integer fraction of the CPU discretization time that is larger than the required calculation time. The step size is shown in the web interface and the upper right corner of the front display of the RT Box.

For reference, the smallest possible FlexArray solver step size for the given model is displayed in the diagnostics messages in the web interface of the RT Box. This value may be used to choose a suitable CPU discretization time (as an integer multiple of the smallest possible FPGA simulation time) to achieve the smallest possible time step.

Distributed Realtime Simulation

A simulation model may be split up and run on multiple hardware nodes in parallel. The advantages of this approach are:

- Increased number of I/Os
- Shorter simulation time steps

However, running different parts of a model on different hardware nodes also poses some difficulties:

- The nodes may need to exchange information in every simulation step.
- The I/Os of the different nodes must be synchronized to guarantee consistent electrical states.
- The simulation startup must be synchronized to guarantee consistent model states.

This chapter describes how distributed realtime simulation can be facilitated using multiple RT Boxes with minimal additional modifications to the simulation model.

Model Setup for Distributed Realtime Simulation

Identifying Suitable Subsystems

As a first step the simulation model needs to be divided into suitable subsystems for parallel simulation. Obvious candidates for independent subsystems are isolated electrical circuits.

Another common solution is to separate circuit models at a capacitor or inductor that can be replaced by a current source in one part of the model and a voltage source in the other part. Both sources are controlled by respective measurements in the other part of the model. This approach can often be applied to DC-link capacitors: Note that in an offline simulation a Delay block is necessary in

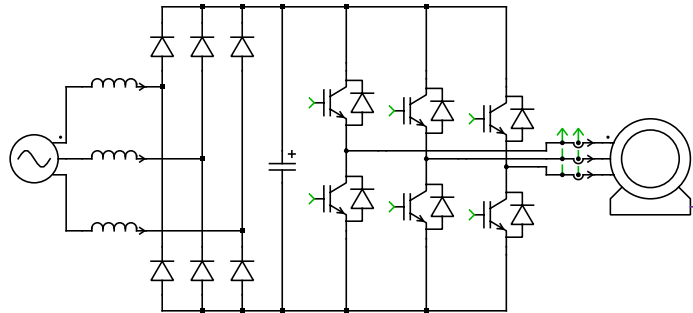

Model with DC-link before split-up

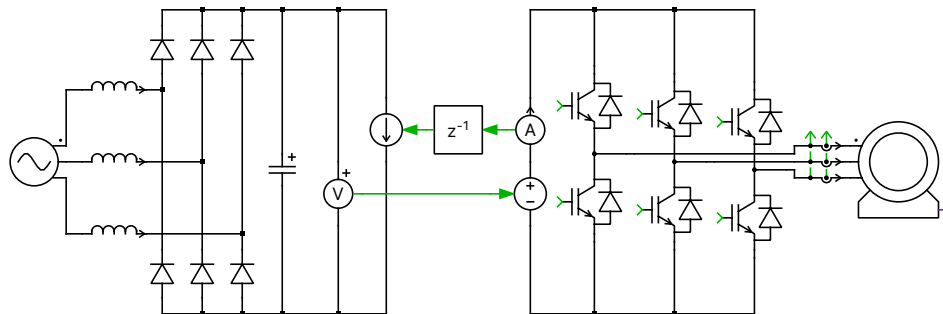

Model with DC-link after split-up

at least one direction of communication to prevent algebraic loops.

Exchanging signals between two models

For physical distribution of the model onto different RT Boxes the code for each part of the model must be generated separately. Therefore we need to create a subsystem for each RT Box and place the corresponding part of the model inside it.

The signals between the subsystems are now replaced by SFP blocks. The SFP ports establish a high-speed bidirectional serial communication link between two RT Boxes with a bandwidth of 6.25 Gbps. To send signals from a model over a SFP port use the SFP Out block (see page 86). To receive signals from an SFP port and use it in a model use the SFP In block (see page 85). The SFP com-

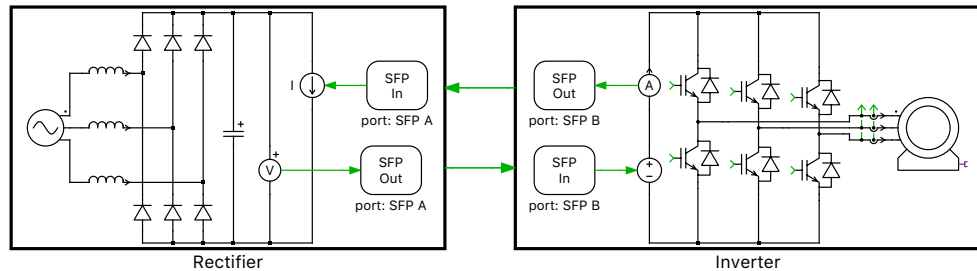

Model with communication over SFP

munication introduces a latency of two simulation timesteps (i.e. model B processes the information from model A two timesteps after it was processed by Model A). For offline simulations, these delays are modelled internally in the SFP blocks, so no external delay block is necessary anymore.

In this example, SFP port A is used on the first box running the rectifier and SFP port B is used on the second box running the inverter. This assumes that a SFP cable connects port A on the first box with port B on the second box.

Signal relaying

Signals can be exchanged between any two boxes that have a direct physical SFP connection. To exchange signals between boxes that are connected only via other boxes, signal relaying must be manually provided on the boxes in between:

In the case shown above the latency for a signal from Model A to Model C (and vice versa) is four simulation steps.

Time and Startup Synchronization

In addition to simulation data exchange, the SFP connection allows synchronizing the simulation time steps and the simulation startup between multiple RT

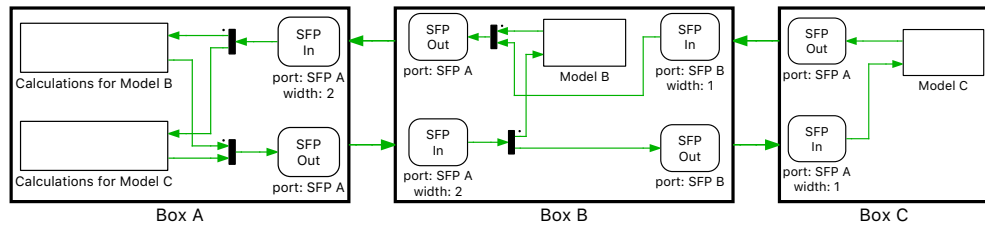

Signal relaying

Boxes. Synchronization requires assigning “primary” and “secondary” roles to SFP ports. For time step synchronization the clock signal from the primary box is distributed to a number of secondary boxes. All boxes with time step synchronization enabled must use the same simulation step time.

For startup synchronization the primary box first waits for all registered secondary boxes to become available (and optionally synchronized with the primary clock). Then the primary box sends a start signal to all secondary boxes simultaneously and also starts its own simulation model.

The assignment of primary and secondary roles is done in the **Interconnect** settings of the RT Box specific coder options. Please see section “RT Box Coder Options” (on page 32) for further details.

Note that one RT Box can connect to a primary box on one SFP port and act as a primary box for further RT Boxes connected to the other SFP ports. This results in a tree-like structure where the clock signal is distributed from the tree root to the subsequent levels. However, you should consider that clock jitter increases with each level that is added to the tree. Configuration settings for four RT-Boxes arranged in a tree with 3 levels are shown in the figure below.

Synchronized versus Unsynchronized Simulation

As stated above, the latency of a signal sent from one box to another box is two simulation steps when the two boxes use synchronized simulation time steps. This is the best solution for distributed simulations where the calculation time for each simulation step is roughly the same on all boxes.

Another common scenario is to use additional RT Boxes for I/O extension only. To minimize I/O latency it may be advisable to not use simulation time step synchronization. The RT Boxes running as I/O extender should run very simple models that only connect incoming SFP blocks to peripheral blocks and vice



Startup and time synchronization in a 3 level tree

versa. These models can typically be run with a step size of just $1 \mu s$. In this case, the SFP latency is reduced to the step size of the fast I/O extenders plus

the time needed for SFP data transmission (typically well below $1 \mu\text{s}$).

Another scenario where time step synchronization is not recommended is when splitting the model into a fast part (e.g. for the electrical system) and a slow part (e.g. the mechanical system). Both parts can then run on two RT Boxes with different time steps.

Scripting

For automated test environments the RT Box can be controlled via external scripts using an RPC interface. RPC is a lightweight protocol for executing functions on a remote machine. The RT Box acts as an RPC server, which processes requests sent from scripts running on another computer. Many scripting languages support RPC out of the box, for example Python or Ruby.

For Python, extensions for XML/JSON-RPC support are available. XML-RPC is an RPC protocol that uses XML to encode its calls. JSON-RPC is an RPC protocol that uses JSON-encoded messages. They both use HTTP as a transport mechanism.

In the following examples, Python 3.x syntax and script excerpts are used.

Establishing an XML/JSON-RPC Connection to the RT Box

The RT Box listens to RPC connections on TCP port 9998. The following Python code initiates an XML/JSON-RPC connection to the RT Box:

```
import socket
ip = socket.gethostbyname("examplebox.local")
```

- For XML format:

```
import xmlrpc.client
server = xmlrpc.client.ServerProxy("http://" + ip +
":9998/RPC2")
```

- For JSON format:

```
import jsonrpc_requests
server = jsonrpc_requests.Server("http://" + ip +
":9998/RPC2")
```

Note that the URL must end with `"/RPC2"`, which is an XML/JSON-RPC convention.

Overview of XML-RPC Commands

Commands for RT Box start with `rtbox` followed by a dot. In Python they are invoked on the server object, for example

```
server.rtbox.start()
```

Loading, starting and stopping a real-time simulation

The command

```
rtbox.load(binaryObject)
```

loads a new executable (ELF file) on the RT Box. The parameter *binaryObject* must be a base64 encoded RPC binary object. For XML format in Python, this object can be directly created using the Binary object from `xmlrpc.client`. The following code shows how to read an ELF executable file and load it on the RT Box using Python.

- For XML format:

```
with open("TestModel_codegen/TestModel.elf", "rb") as f:
    server.rtbox.load(xmlrpc.client.Binary(f.read()))
f.closed
```

- For JSON format:

```
import base64 # deserialise MAT-file contents for JSON-RPC
with open("TestModel_codegen/TestModel.elf", "rb") as f:
    server.rtbox.load(base64.b64encode(f.read()).decode())
f.closed
```

The command

```
rtbox.start()
```

starts the execution of the real-time simulation.

The command

```
rtbox.stop()
```

stops the execution of the real-time simulation.

The command

```
rtbox.reboot('reboot')
```

stops the execution of the real-time simulation and reboots the RT Box.

The command

```
rtbox.querySimulation()
```

returns a struct with (at least) the following fields:

modelName

The name of the model or subsystem that is currently executed.

sampleTime

The base discretization step size of the model.

status

The current execution state of the simulation. Possible values are "stopped", "running" and "error".

The command

```
rtbox.getApplicationLog()
```

returns the log messages from the running simulation.

Sending data to the real-time simulation

The command

```
rtbox.setProgrammableValue('componentPath', valueList)
```

sets the output of the Programmable Value block (see page 68) indicated by *componentPath*. The parameter *componentPath* is the path of the block relative to the code generation subsystem. The parameter *valueList* must be an XML-RPC array where the number of elements corresponds to the width of the output signal. If the Programmable Value Block has an output signal with a width of 1 a scalar value may be used as parameter. The example code below changes an output of width 2 to the values 5 and 7:

```
rtbox.setProgrammableValue('Value1', [5.0, 7.0])
```

Another example shows setting an output of width 1 to the value 7:

```
rtbox.setProgrammableValue('Value1',[7])
```

or

```
rtbox.setProgrammableValue('TestModel/Value1',7)
```

Getting data from the real-time simulation

The command

```
rtbox.getCaptureData('componentPath')
```

returns the last filled data buffer from the Data Capture block (see page 57) indicated by *componentPath*. The parameter *componentPath* is the path of the block relative to the code generation subsystem. The returned value is a struct with the following fields:

data

The data as a two-dimensional array. The inner dimension corresponds to the width of the input signal, the outer dimension corresponds to the number of samples.

triggerCount

Specifies how many times the sample buffer has been filled.

sampleTime

Specifies the time between two samples, in seconds.

The command

```
rtbox.getCaptureTriggerCount('componentPath')
```

returns how many times the sample buffer of the Data Capture block (see page 57) indicated by *componentPath* has been filled. The parameter *componentPath* is the path of the block relative to the code generation subsystem.

The command

```
rtbox.getDataCaptureBlocks()
```

returns a list of all Data Capture blocks in the current model, with path.

The command

```
rtbox.getProgrammableValueBlocks()
```

returns a list of all Programmable Value blocks in the current model, with path.

Example Script

This Python script loads a new executable on the RT Box and starts it. It sets a value and reads some values back from the model after the corresponding data block has captured sufficient data. The Data Capture block “Capture1” and the Programmable Value block “Value1” must be placed in the root schematic of the model. Finally, the real-time simulation is stopped.

```
import socket
import xmlrpc.client
import random
import time

ip = socket.gethostbyname("examplebox.local")
server = xmlrpc.client.ServerProxy("http://" + ip +
":9998/RPC2")

with open("TestModel_codegen/TestModel.elf", "rb") as f:
    print("Uploading executable")
    server.rtbox.load(xmlrpc.client.Binary(f.read()))
f.closed
print("Starting executable")
server.rtbox.start()
print("Simulation running")
val = random.random()
print("Setting value %.7f" % val)
server.rtbox.setProgrammableValue('Value1', [val])
while server.rtbox.getCaptureTriggerCount('Capture1') == 0:
    print("Waiting for data")
    time.sleep(1)

data = server.rtbox.getCaptureData('Capture1')
print("Got value %.7f" % data['data'][0][0])
print("Stopping executable")
server.rtbox.stop()
```

RT Box Target Support Library Component Reference

This chapter lists the contents of the RT Box Target Support library in alphabetical order.

Analog In

Purpose Output the measured voltage at an analog input channel.

Description The output signal is scalable and can be used with an offset. The output signal is calculated as $\text{input} * \text{Scale} + \text{Offset}$.



Parameters

General

Analog input channel(s)

Index of the analog input channel. For vectorized input signals a vector of input channel indices must be specified.

Scale

A scale factor for the input signal.

Offset

An offset for the scaled input signal.

Trigger

Trigger source

If “Global setting” is selected, the Analog In measurements happen simultaneously, once per simulation step, as configured in the *Analog input sampling* of the Coder Options Dialog (see section “General” on page 31). Otherwise, continuous ADC sampling is activated and Analog In measurements can get triggered individually. When “Specify delay within simulation step” is selected, the “Trigger delay(s)” field allows to setup individual software triggers. When “Use PWM trigger port” is selected, a trigger block input is enabled, that is intended to get connected to an ADC trigger output of a PWM Out block.

Trigger delay(s)

Trigger delay for the measurement in seconds. Only available when Trigger source is configured as “Specify delay within simulation step”. The parameter can be either a scalar or a vector with the same width as the number of input channels.

Analog Out

Purpose Set the output voltage of an analog output channel.

Description The output voltage is scalable and can be used with an offset. The output voltage is calculated as $\text{input} * \text{Scale} + \text{Offset}$. Further, an output voltage limitation can be set.

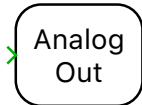

Parameters

Analog output channel(s)

Index of the analog output channel. For vectorized output signals a vector of output channel indices must be specified.

Scale

A scale factor for the output signal.

Offset

An offset for the scaled output signal.

Minimum output voltage

The lowest value that the output voltage can reach.

Maximum output voltage

The highest value that the output voltage can reach.

CAN Receive

Purpose Receives CAN messages.

Description

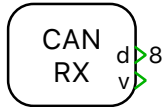

The block initiates the reception of CAN messages with the given ID on the given CAN interface. On reception of a CAN message the data is made available on the block output **d** as a vectorized signal consisting of 8 bytes. The output **v** is **1** in each simulation step where new data is received, **0** otherwise.

The data at block output **d** always has a width of 8 bytes regardless of the length of the received CAN message.

Parameters

CAN interface

The CAN interface to use. The selected CAN interface must be configured in the RT Box Coder Options Dialog (see section “CAN” on page 33).

CAN ID source

Selects whether the CAN ID is specified as a parameter or is supplied as an input signal.

CAN ID

The CAN identifier for which this block receives CAN messages. The CAN ID can be supplied as either a 11 bit value (for CAN 2.0A) or 29 bit value (for CAN 2.0B).

Frame format

Specifies the frame format that is used when filtering for matching CAN messages. Possible values are:

- **Base** for CAN 2.0A messages with an 11 bit identifier
- **Extended** for CAN 2.0B messages with an 29 bit identifier
- **Auto** uses the **Base** format if the specified **CAN ID** is smaller than 2047. Otherwise, the **Extended** format is used.

Offline simulation

Enables or disables data injection in an offline simulation. If set to **enabled**, terminals are added to the subsystem for which code is generated. In an offline simulation the data which is to be received by the CAN Receive block can be injected into these terminals. The block must be placed in the root schematic of the subsystem for which code is generated. If set to **disabled**, no such terminals will be added and the block can be used at any subsystem level.

CAN Transmit

Purpose Transmits CAN messages.

Description

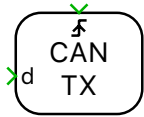

The CAN Transmit block sends out data on a CAN bus. The data to send must be provided on the block input **d** as a vectorized signal with data type **uint8**. The length of the transmitted CAN message is determined by the width of the input signal (1 to 8 bytes).

Messages are either sent regularly with a fixed sample time or on demand when the trigger input changes. When configured for triggered execution, messages are sent when the trigger signal changes in the manner specified by the **Trigger type** parameter:

rising

Data is sent when the trigger signal changes from 0 to a non-zero value.

falling

Data is sent when the trigger signal changes from a non-zero value to 0.

either

Data is sent when the trigger signal changes from 0 to a non-zero value or vice versa.

Parameters

CAN interface

The CAN interface to use. The selected CAN interface must be configured in the RT Box Coder Options Dialog (see section “CAN” on page 33).

CAN ID source

Selects whether the CAN ID is specified as a parameter or is supplied as an input signal.

CAN ID

The CAN identifier that is used for CAN messages sent by this block. The CAN ID can be supplied as either an 11 bit value (for CAN 2.0A compliance) or 29 bit value (for CAN 2.0B compliance).

Execution

Selects between **regular** and **triggered** execution.

Sample time

The time period for regular packet transmission (for regular execution only).

Trigger type

The direction of the edges of the trigger signal upon which the data is sent, as described above (for triggered execution only).

Offline simulation

Enables or disables data inspection in an offline simulation. If set to **enabled**, terminals are added to the subsystem for which code is generated. In an offline simulation the data sent to the CAN Transmit block is available at these terminals. The block must be placed in the root schematic of the subsystem for which code is generated. If set to **disabled**, no such terminals will be added and the block can be used at any subsystem level.

Data Capture

Purpose

Capture data to be transferred via XML-RPC.

Description

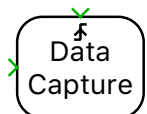

The Data Capture block captures simulation data from real-time simulations that are controlled by an external script. The captured data can be queried via the XML-RPC interface of the RT Box.

All captured data is written into an internal buffer first. The size of the buffer is controlled by the parameter “Number of samples”. Once the buffer is full, the data can be read via XML-RPC. See “Getting data from the real-time simulation” on page 48 for a description of XML-RPC commands to access the Data Capture block.

The start of data capturing can be controlled with an optional trigger signal.

Parameters

Number of samples

The number of samples that are captured before data is accessible via XML-RPC.

Trigger type

Specifies the edge of the trigger signal that starts data capturing. With the setting **continuous**, the data acquisition is always active. When set to **once at startup**, the data buffer is filled once when the simulation is started. In both cases, the trigger input is ignored.

Trigger level

Defines the value that the trigger signal must reach to become active.

Digital In

Purpose Read a digital input.

Description The output signal is 1 if the input voltage is higher than 2 Volts and 0 if it is lower than 0.8 Volts. For other input voltages the output signal is undefined.



Parameters

Digital input channel(s)
Index of the digital input channel. For vectorized input signals a vector of input channel indices must be specified.

Input characteristic
Specifies whether an internal pull-up (10 k Ω against 3.3 Volt) or pull-down resistor (10 k Ω against GND) is connected to the digital input.

Digital Out

Purpose Set a digital output.

Description The output is set low if the input signal is zero, it is set high for all other values. During an offline simulation the block behaves like a simple feedthrough.



Parameters **Digital output channel(s)**
Index of the digital output channel. For vectorized output signals a vector of output channel indices must be specified.

Digital Out Override

Purpose Override a digital output set by another block.

Description

en Digital Out
in Override

The Digital Out Override block is intended to be used in parallel with another block that controls a digital output channel. If 'en' is low, the other block has full control of the output channel. If 'en' is high, then the output channel is set to the value of 'in'.

The Digital Out Override block cannot be used to override PWM outputs that are protected by a Powerstage Protection Unit.

Parameters

Digital output channel(s)

Index of the digital output channel that will be overridden. For vectorized output signals a vector of output channel indices must be specified.

EnDat Sensor

Purpose

Provide an EnDat sensor implementation to transmit position information.

Description

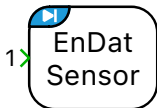

The EnDat sensor takes a rotational angle θ as input.

The EnDat sensor is available on RT Box 2 and RT Box 3 with hardware revision 1.2 and later. It supports a subset of the EnDat 2.1 command set, in particular:

Supported mode commands

Mode command	M2	M1	M0	(M2)	(M1)	(M0)
Encoder send position values	0	0	0	1	1	1
Selection of memory area	0	0	1	1	1	0
Encoder send parameter (for selected parameters, see below)	1	0	0	0	1	1
Encoder receive parameter	0	1	1	1	0	0
Encoder receive reset	1	0	1	0	1	0

The following parameters can be queried using a combination of mode commands "Selection of memory area" and "Encoder send parameter":

Supported parameters

Parameter	Parameter no.	MRS code
EnDat version	8	161
Resolution	13	161
EnDat command set	42	165

In each of the EnDat OEM parameter areas (MRS codes 169, 171, 173 and 175) a range of 256 words may be written (using the "Encoder receive parameter" command) and read back (using the "Encoder send parameter" command).

An EnDat Controller must be connected to the RS-232/422/485 port on the back of the RT box. The connector layout for the EnDat sensor is shown below:

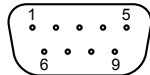

9 pin male D-Sub (front view)

Pinout of the RS-232/422/485 connector for EnDat usage

Pin	EnDat
1	n/c
2	n/c
3	CLK+
4	DATA+
5	GND
6	DATA-
7	CLK-
8	n/c
9	n/c

The EnDat connector is electrically isolated from the rest of the RT Box. The GND line of the EnDat connector needs to be connected to the controller board.

Parameters

General

Resolution (bits)

Specifies the resolution of the EnDat position signal, in bits. The maximum resolution is 31 bits.

Advanced

Maximum clock pulse width (s)

Specifies the maximum duration of a positive or negative clock pulse. If a transfer is active and the clock line remains stable for longer than the specified time, the internal state machine of the EnDat receiver is reset and the start of a new transfer is expected. The allowed range for this parameter is $10\mu s$ to $650\mu s$, the default is $100\mu s$.

Allow dynamic (dis-)connect

If enabled, an additional input port named **en** is shown. This port can be used to simulate a connection failure (see below).

Additional initialization code

Allows to add C code that is executed during the initialization of the EnDat block.

This parameter can be used to initialize the OEM parameter area using the command

plxWriteEndatMemory(uint8_t aMrsCode, uint8_t aAddress, uint16_t aValue), where

aMrsCode is the MRS code of the OEM area (169, 171, 173 or 175),

aAddress is the address within the OEM area (0-255) and

aValue is the value to write to the address (0-65535).

Inputs

θ

The rotational angle or rotor position, in rad.

en

If the parameter **Allow dynamic (dis-)connect** is set to enabled, a boolean signal 0 on this port deactivates all EnDat communication, i.e. the RT Box no longer responds to EnDat commands. A boolean signal 1 on this port activates the EnDat operations.

Incremental Encoder

Purpose Generate quadrature encoder signals on digital outputs.

Description

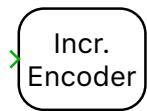

The Incremental Encoder takes a rotational angle θ as input and generates quadrature encoder signals with an optional index pulse on selected digital outputs of the RT Box. During an offline simulation the pulses are available on the outputs.

The RT Box contains two independent Incremental Encoder units.

Parameters

General

Line pairs

Defines the amount of pairs of black and white lines and therefore the encoder resolution. For every line pair, 4 state transitions at A, B per revolution can be seen. The index pulse at I is set once per revolution when the angle crosses 0.

Coding in forward direction

Defines the A,B state sequence in forward direction.

Output when $\theta=0$

Specifies the value of signals A and B when the input angle θ is zero and an index pulse is generated.

Offline implementation

With the setting **Continuous** θ and ω are made available in for offline simulation. With the setting **Quadrature Encoded** the quadrature signals A , B and I are made available as a vectorized signal.

Output

Digital encoder output [A] or [A, /A]

Indices of the digital outputs for signal A . If the signal is differential the value must be a vector with two elements where the second element specifies the output for the differential signal \bar{A} . For single-ended outputs the value must be a scalar or a vector with one element.

Digital encoder output [B] or [B, /B]

Indices of the digital outputs for signal B . If the signal is differential the value must be a vector with two elements where the second element specifies the output for the differential signal \bar{B} . For single-ended outputs the value must be a scalar or a vector with one element.

Digital index output [I] or [I, /I]

Indices of the digital outputs for index signal I . If the signal is differential the value must be a vector with two elements where the second element specifies the output for the differential signal \bar{I} . For single-ended outputs the value must be a scalar or a vector with one element. If the index signal output is not needed the value must be an empty vector.

Inputs θ

The rotational angle or rotor position, in rad.

Powerstage Protection Unit

Purpose Provide safety features for PWM outputs.

Description

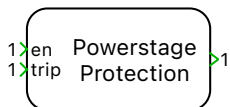

The Powerstage Protection Unit enables PWM outputs to be switched to a safe state. The safe state is active while a logic high level is detected on one of the fault detection inputs (digital inputs or **trip** block input). The Powerstage Protection Unit also enters safe state at the start of the simulation if the **Reset behavior** parameter is set to **Rising edge at 'en' block input**, otherwise the initial state depends on the state of the fault detection inputs.

It is possible to configure whether normal operation should be resumed either on the rising edge of a model signal or automatically when the fault detection inputs become 0. The output of the Powerstage Protection Unit is 0 when the unit is in safe state, otherwise 1. The safe state of the PWM signals is configured in the PWM block.

An unconfigured Powerstage Protection Unit (for which there is no block in the simulation model) is automatically set to normal operating mode when the simulation is started. Since no inputs are configured, it never enters the safe state.

Parameters

Protection unit

The Powerstage Protection Unit to configure.

Tripping via block input

If set to **enabled**, safe state is reached when a non-zero signal is detected on the **trip** block input. The block input is hidden when this parameter is set to **disabled**.

Tripping via digital input(s)

Configures the digital inputs which are monitored. The Powerstage Protection Unit switches to safe state while a high input is detected on one of the digital inputs. The parameter can be either a scalar or a vector with up to three input signal indices. If left empty or an empty vector is specified, no digital input is monitored.

Digital input characteristic

Specifies whether an internal pull-up or pull-down resistor is connected to the digital inputs.

Reset behavior

Specifies when to resume normal operation. If set to **Rising edge at 'en' block input** the Powerstage Protection Unit waits for a rising edge on the **en** block input after all fault detection inputs are 0 before resuming normal

operation. If set to **Automatic**, normal operation resumes when all fault detection inputs are 0, ignoring the **en** model input.

Inputs

en

A rising edge on the **en** block input resumes normal operation if all fault detection inputs (digital inputs and **trip** block input) are 0. This input is hidden when the parameter **Reset behavior** is set to **Automatic**.

trip

Any value other than 0 on the **trip** block input switches the Powerstage Protection Unit into safe state. This input is hidden when the parameter **Trip via block input** is set to **disabled**.

Programmable Value

Purpose Output values received via the XML-RPC interface.

Description

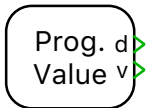

The output of the Programmable Value block can be set via the XML-RPC interface. See “Sending data to the real-time simulation” on page 47 for a description of XML-RPC commands to access the Programmable Value block.

An output value of 1 at the **v** port indicates that new data has been received via XML-RPC.

Parameters

Width

The width of the outgoing signal.

Initial value

The output value of the block before data has been received via XML-RPC.

PWM Capture

Purpose

Averages a digital input over the period of a model step.

Description

PWM
Capture

The PWM Capture output represents the percentage of time during which a digital input signal was active over the last model step period. The PWM capture active polarity can be set channel wise. During an offline simulation the percentage time in the active state within the last simulation step is calculated.

The RT Box FPGA sample time of the incoming PWM is:

- 3.75 ns (clock frequency of 266 MHz) for RT Box 1 or CE;
- 3.33 ns (clock frequency of 300 MHz) for RT Box 2 or 3.

Note that for step size larger than $15.3 \mu\text{s}$ on RT Box 1 or CE, and $13.6 \mu\text{s}$ on RT Box 2 or 3, the following resolution will be used: 7.5 ns for RT Box 1 or CE; 6.66 ns for RT Box 2 or 3.

Next for each multiple of these times, the sample rate changes again. This means, e.g. for RT Box 2 or 3, for step size larger than $27.2 \mu\text{s}$, 10 ns resolution is used; for step size larger than $40.8 \mu\text{s}$, 13.3 ns resolution is used; etc.

Parameters

Digital input channel(s)

Index of the digital input channel. For vectorized input signals a vector of input channel indices must be specified.

Channel(s) active polarity

Active level of a digital input. For vectorized input signals either a scalar or a vector with the length of the input channels must be specified.

Offline behavior

Configures the averaging interval for the offline simulation to match the connected power module configuration. Possible values are **Sub-cycle average** for power modules that use sub-cycle averaging or **Nanostep** for power modules that employ a Nanostep solver.

Input characteristic

Specifies whether an internal pull-up or pull-down resistor is connected to the digital input.

PWM Out

Purpose Generate a PWM signal on a digital output.

Description



The PWM Out generates a configurable PWM signal on a digital output of the RT Box. The modulation index for each channel must be provided via the input signal, which is a vectorized signal if the block uses multiple channels. During an offline simulation it behaves as a normal PWM generation block.

Parameters

General

Digital output channel(s)

Index of the digital output channel. For vectorized output signals a vector of output channel indices must be specified.

Carrier type

Selects the carrier waveform, either sawtooth or symmetrical.

Carrier frequency

The frequency of the carrier in hertz (Hz).

Carrier phase shift

The phase shift of the carrier signal, in p.u. of the carrier period. The parameter can be either a scalar or a vector with the same width as the number of output channels.

Carrier limits

The range of the carrier signal. The default is $[-1 \ 1]$.

Turn-on delay

Turn-on delay of the PWM output in seconds.

Polarity

The polarity of the PWM output determines whether the PWM signal is in on-state (value 1) or off-state (value 0) when the modulation index exceeds the carrier. The parameter can be either a scalar or a vector with the same width as the number of output channels.

Update

If “On carrier minimum”, “On carrier maximum” or “On carrier minimum/maximum” is selected the modulation index will be sampled when the carrier reaches its minimum or maximum values. If “Immediately” is selected

the modulation index will be updated after each simulation step of the RT Box.

Synchronization with model step

If “Enabled” is selected and the discretization step size is an integer multiple of the PWM period, the PWM generation will be synchronized with the simulation steps of the RT Box. If the block is placed inside of a task frame, the step size of the task frame will be used for synchronization.

Protection

Safe state

Specifies the state to which the output signal is set when the Powerstage Protection Unit is activated. A value of 0 indicates a low signal value (0 Volts), a value of 1 indicates a high signal value (3.3V or 5V, depending on the output voltage level). The parameter can be either a scalar or a vector with the same width as the number of output channels.

Powerstage protection unit

Specifies the Powerstage Protection Unit that is associated with this PWM block. Up to four Powerstage Protection Unit can be configured per model. See Powerstage Protection Unit (see page 66) for details.

Advanced

Active polarity for turn-on delay

Specifies whether the turn-on delay is applied during the rising edge (1, default) or the falling edge (0) of the PWM signal. The polarity should be changed to 0 only for switches that are turned on when the output voltage is 0 Volts. This parameter has no influence on the polarity nor the safe state of the output signal. The parameter can be either a scalar or a vector with the same width as the number of output channels.

ADC trigger output

Allows to generate an ADC trigger output, either “On carrier minimum”, “On carrier maximum” or “On carrier minimum/maximum”. This block output is hidden when “Disabled” is selected. Otherwise, the ADC output is intended to get connected to a trigger input of an Analog In block.

PWM Out (Variable)

Purpose Generate PWM signals with variable frequency and variable phase-shift.

Description



The PWM Out (Variable) block generates PWM signals on one or multiple digital output channels of the RT Box. The modulation index for each channel must be provided via the input signal m , which is a vectorized signal if the block uses multiple channels.

The carrier frequency f_c is common to all channels of the same block. It can be controlled during the simulation using the scalar input signal f'_c . The resulting carrier frequency f_c is calculated as the product of the nominal carrier frequency specified in the block parameters and the input signal f'_c . For a constant carrier frequency, a constant value 1 must be fed into the block. If the PWM generation is synchronized to the simulation steps of the RT Box, the carrier frequency is rounded to the nearest integer multiple of the simulation frequency.

The phase shift between the carriers of the individual PWM channels can be controlled with the vectorized input signal ph' . Each element of ph' specifies the phase delay of the PWM carrier in the corresponding channel. The delay is given in p.u. of the carrier period and must lie between 0 and 1.

By enabling the “Variable turn-on delay mode” (in the advanced parameters section), the input signal ph' gets replaced with input signal d' , that controls the turn-on delay (in seconds) for the individual PWM channels.

PWM generation limits

In order to understand the operational limits of the PWM generation an overview is given as follows:

The PWM generation ratings (i.e. maximum/minimum operating frequencies, maximum/minimum duty cycle resolution, etc.) depend on the selected nominal carrier frequency specified in the block parameters.

The PRD value of each PWM carrier signal is a 16-bit number. This sets a limit on the maximum PWM carrier period (minimum PWM carrier frequency) to a length of 2^{16} FPGA clock periods. Nevertheless, the maximum PWM carrier period can be increased, by increasing the FPGA clock period, with the use of a prescaler. The prescaler is selected as the minimum integer so that the nominal carrier frequency specified in the block parameters can be realised.

The minimum achievable PWM period (maximum PWM frequency) is set to be 20 FPGA clock periods. The maximum and minimum PWM carrier frequencies can be calculated as follows:

$$f_{\min} = \frac{1}{T_{\max}}, \quad T_{\max} = \frac{2^{\text{prescaler}}}{f_{\text{FPGA}}} \cdot 2^{16}.$$

$$f_{\max} = \frac{1}{T_{\min}}, \quad T_{\min} = \frac{2^{\text{prescaler}}}{f_{\text{FPGA}}} \cdot 20.$$

The duty-cycle, frequency, and phaseshift resolution will depend on the PWM carrier frequency being employed. The lowest resolution is obtained when operating at the highest PWM frequency. In case of a sawtooth carrier the lowest resolution is $1/20 = 5\%$, while the highest is $2^{-16} = 0.00153\%$. In case of a symmetrical carrier, the resolution is half of the sawtooth carrier resolution.

When frequency modulation is employed, the following table shows the maximum and minimum operating frequencies depending on the selected nominal carrier frequency for each of the RT Box models.

RTBox 2/3 with 150 MHz FPGA clock frequency

Selected nominal frequency	Minimum operating frequency	Maximum operating frequency
$2.288 \text{ kHz} < f_c < 7.500 \text{ MHz}$	2.288 kHz	7.500 MHz
$1.144 \text{ kHz} < f_c < 2.288 \text{ kHz}$	1.144 kHz	3.750 MHz
$572.2 \text{ Hz} < f_c < 1.144 \text{ kHz}$	572.2 Hz	1.875 MHz
$286.1 \text{ Hz} < f_c < 572.2 \text{ Hz}$	286.1 Hz	937.5 kHz
$143 \text{ Hz} < f_c < 286.1 \text{ Hz}$	143 Hz	468.7 kHz
$71.52 \text{ Hz} < f_c < 143 \text{ Hz}$	71.52 Hz	234.4 kHz
$35.7 \text{ Hz} < f_c < 71.52 \text{ Hz}$	35.7 Hz	117.26 kHz

The tables show the frequency values for prescaler values from 0 to 6. Since the prescaler is a 4-bit number, and its maximum value is 15, the minimum achievable operating frequency would be 0.0621 Hz for RT Box CE/1, and 0.07 Hz for RT Box 2/3.

RTBox CE/1 with 133 MHz FPGA clock frequency

Selected nominal frequency	Minimum operating frequency	Maximum operating frequency
$2.035 \text{ kHz} < f_c < 6.667 \text{ MHz}$	2.035 kHz	6.667 MHz
$1.017 \text{ kHz} < f_c < 2.035 \text{ kHz}$	1.017 kHz	3.333 MHz
$508.6 \text{ Hz} < f_c < 1.017 \text{ kHz}$	508.6 Hz	1.667 MHz
$254.3 \text{ Hz} < f_c < 508.6 \text{ Hz}$	254.3 Hz	833.3 kHz
$127.2 \text{ Hz} < f_c < 254.3 \text{ Hz}$	127.2 Hz	416.6 kHz
$63.6 \text{ Hz} < f_c < 127.2 \text{ Hz}$	63.6 Hz	208.3 kHz
$31.8 \text{ Hz} < f_c < 63.6 \text{ Hz}$	31.8 Hz	104.2 kHz

Note Keep in mind that the prescaler is calculated once during the compilation process, and it is not modified during runtime. Therefore, in case of variable frequency operation, the nominal frequency should be selected as the lowest frequency required during operation.

PWM implementation details

To understand the PWM generation for variable frequency and variable phase-shift, an overview of the internal implementation is given:

Each PWM channel has its own a ramp generator for a carrier signal. In case of a sawtooth carrier, the carrier signal ramps up with a constant slope from its initial value 0 to reach the value PRD at the end of the PWM period. When it reaches PRD, the carrier is instantaneously reset to 0. The period PRD is computed as the inverse of the current carrier frequency f_c . In case of a symmetrical carrier, the rising ramp reaches its maximum value PRD/2 after half the PWM period and the carrier then ramps down to reach 0 at the end of the PWM period.

The modulation index for each channel is mapped from its original input range defined by the carrier limits to a compare value CMP. CMP has a minimum

value of 0 and a maximum value of PRD for sawtooth carriers or PRD/2 for symmetrical carriers. If the parameter **Polarity** of a channel is set to 0 its PWM output becomes high whenever CMP is greater than the carrier signal.

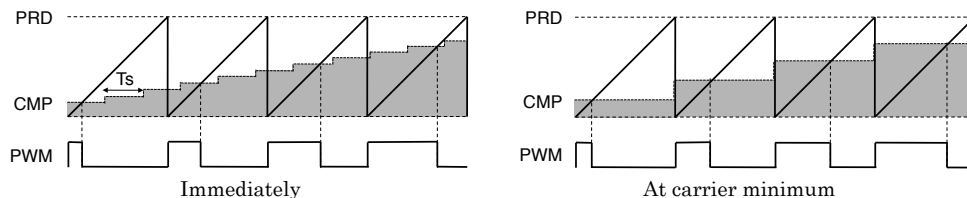

Update schemes for modulation index with sawtooth carrier

The user can choose how often the CMP value is updated. If the parameter **Update** is set to “Immediately”, CMP will be updated asynchronously whenever a new modulation index has been computed in a model step. This can be helpful if the simulation step size is much shorter than the PWM period. For updating CMP synchronously after every complete PWM period, the parameter **Update** must be set to “At carrier minimum”. In case of a symmetrical carrier, there are two additional options available for synchronously updating CMP: If the parameter **Update** is set to “At carrier maximum”, CMP will be refreshed in the middle of the PWM period at the tips of the carrier. If set to “At carrier minimum and maximum” the update will be performed twice in every PWM period.

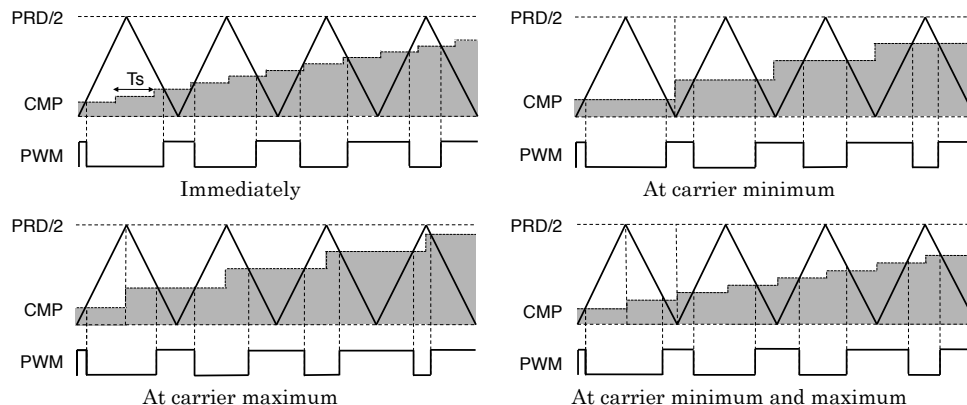

Update schemes for modulation index with symmetrical carrier

If a PWM Out (Variable) block contains multiple output channels, the first

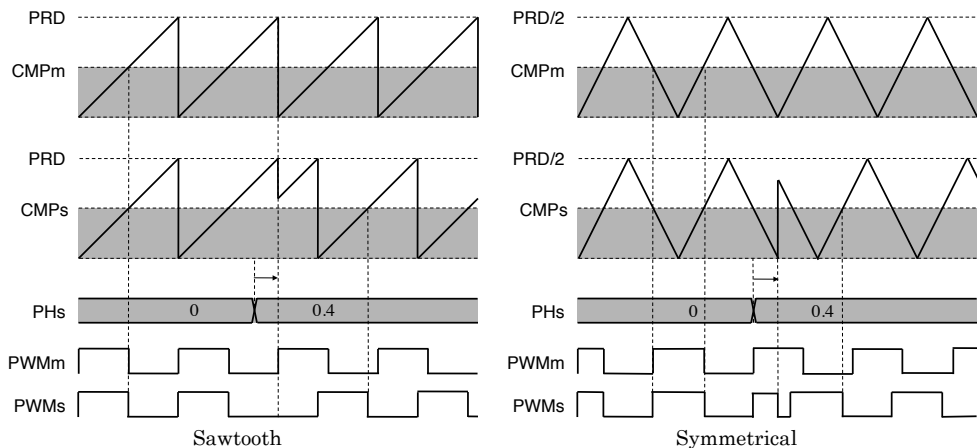

Phase-shift variation with different carrier types

channel automatically becomes the primary channel while the other channels are configured as secondary. Every time the ramp generator of the primary channel becomes 0, the primary channel transmits a synchronization signal to the secondary channels of the same block. When this happens, the ramp generators of the secondary channels are set to their initial values computed from the input signal ph' to achieve the desired phase shift.

The first element of the input signal ph' corresponds to the phase delay of the primary channel. The phase delays between multiple PWM Out (Variable) blocks are only defined if the blocks have the same **Nominal carrier frequency**, share a constant frequency input signal f'_c and are synchronized with the simulation steps of the RT Box.

With the synchronization signal from the primary channel, the PWM period is updated as well. A new value of PRD is computed from the carrier frequency and applied to all channels. A change in PRD will change the compare value CMP in order to obtain the desired modulation index.

Parameters

General

Digital output channel(s)

Index of the digital output channel. For vectorized output signals a vector of output channel indices must be specified.

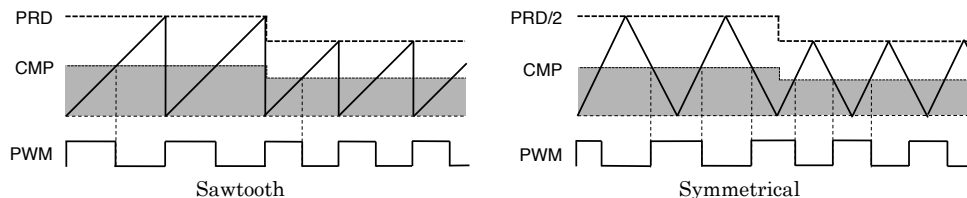

Carrier frequency variation with different carrier types

Carrier type

Selects the carrier waveform, either sawtooth or symmetrical.

Nominal carrier frequency

The nominal frequency of the carrier in hertz (Hz). The actual PWM frequency is equal to the nominal carrier frequency multiplied by the input signal f'_c .

Carrier phase shift

The phase shift of the carrier signal, in p.u. of the carrier period. The parameter can be either a scalar or a vector with the same width as the number of output channels. This field is only available when “Variable turn-on delay mode” is enabled.

Carrier limits

The range of the carrier signal. The default is [-1 1].

Turn-on delay

Turn-on delay of the PWM output in seconds. This field is not available when “Variable turn-on delay mode” is enabled.

Polarity

The polarity of the PWM output determines whether the PWM signal is in on-state (value 1) or off-state (value 0) when the modulation index exceeds the carrier. The parameter can be either a scalar or a vector with the same width as the number of output channels.

Update

If “On carrier minimum”, “On carrier maximum” or “On carrier minimum/maximum” is selected the modulation index will be sampled when the carrier reaches its minimum or maximum values. If “Immediately” is selected the modulation index will be updated after each simulation step of the RT Box.

Synchronization with model step

If “Enabled” is selected and the discretization step size is an integer multiple of the PWM period, the PWM generation will be synchronized with the simulation steps of the RT Box. If the block is placed inside of a task frame, the step size of the task frame will be used for synchronization.

Protection**Safe state**

Specifies the state to which the output signal is set when the Powerstage Protection Unit is activated. A value of 0 indicates a low signal value (0 Volts), a value of 1 indicates a high signal value (3.3V or 5V, depending on the output voltage level). The parameter can be either a scalar or a vector with the same width as the number of output channels.

Powerstage protection unit

Specifies the Powerstage Protection Unit that is associated with this PWM block. Up to four Powerstage Protection Unit can be configured per model. See Powerstage Protection Unit (see page 66) for details.

Advanced**Active polarity for turn-on delay**

Specifies whether the turn-on delay is applied during the rising edge (1, default) or the falling edge (0) of the PWM signal. The polarity should be changed to 0 only for switches that are turned on when the output voltage is 0 Volts. This parameter has no influence on the polarity nor the safe state of the output signal.

Variable turn-on delay mode

When “Enabled” is selected, the input signal ph' gets replaced with input signal d' , that controls the turn-on delay (in seconds) for the individual PWM channels. Additionally, the field “Minimal turn-on delay” allows to specify the lower limit, for safety reasons. The upper limit of the turn-on delay is about 0.4ms. Furthermore, a field to specify constant carrier phase shift per channel is available in the general parameter section.

Minimal turn-on delay

Minimal turn-on delay of the PWM output in seconds. This field is only available when “Variable turn-on delay” is enabled.

ADC trigger output

Allows to generate an ADC trigger output, either “On carrier minimum”, “On carrier maximum” or “On carrier minimum/maximum”. This block output is hidden when “Disabled” is selected. Otherwise, the ADC output is intended to get connected to a trigger input of an Analog In block.

Quadrature Encoder Counter

Purpose

Counts edges generated by a quadrature encoder.

Description

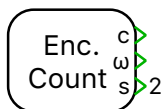

The Quadrature Encoder Counter counts edges which were generated from a quadrature encoder. The A and B outputs of the encoder are connected to digital inputs on the RT Box. Optionally, an index signal I and differential input signals \bar{A} , \bar{B} and \bar{I} can be connected.

The block outputs the current counter value (c), the current velocity in rad/s (ω) and status information (s). The status information output provides a direction signal and a signal indicating whether an index pulse was received during the last simulation step.

The counter counts up or down depending on the sequence of input pulses. The parameter **Direction (rising edge)** specifies the sequence of rising edges which results in incrementing counter values.

Once the counter reaches the value specified in parameter **Maximum counter value** it is reset to zero on the next detected edge in positive direction. Vice versa, the counter is set to **Maximum counter value** when it is zero and detects an edge in negative direction. If connected and configured, the counter is also reset when a positive edge of the index input is detected.

The RT Box contains two independent Quadrature Encoder Counter units.

Parameters

General

Maximum counter value

The counter is reset to zero when it has reached the **Maximum counter value** and detects an input edge in positive direction. The counter is set to the Maximum counter value when it is zero and detects an input edge in negative direction.

For correct velocity output, the **Maximum counter value** must match the number of line pairs of the encoder multiplied by the number of counted edges per line pair (see parameter **Counter mode** below) minus 1. If, for example, the encoder has 1024 line pairs and all edges of A and B are counted, the resulting value is 4095.

Counter mode

Selects which edges of the input signal are counted.

Direction (rising edge)

Selects the sequence of input pulses for incrementing the counter.

Counter reset method

Selects whether the counter should be reset by a positive pulse on the index input or on overflow only.

Counter reset condition

Selects the expected values of A , B and I to detect a counter reset.

Offline implementation

With the setting **Continuous** the inputs θ and ω are made available for offline simulation. With the setting **Quadrature Encoded** the block uses A , B and I as a vectorized input signal.

Input**Input type**

Selects whether the input signals are differential or single-ended.

Index input

If the index input is enabled, the counter is reset when an index pulse is detected.

Digital input(s) for signal [A] or [A, /A]

Indices of the digital inputs for signal A . If the signal is differential the value must be a vector with two elements where the second element specifies the input for the differential signal \bar{A} . For single-ended inputs the value must be a scalar or a vector with one or two elements. The second element is ignored in the latter case.

Digital input(s) for signal [B] or [B, /B]

Indices of the digital inputs for signal B . If the signal is differential the value must be a vector with two elements where the second element specifies the input for the differential signal \bar{B} . For single-ended inputs the value must be a scalar or a vector with one or two elements. The second element is ignored in the latter case.

Digital input(s) for index signal [I] or [I, /I]

Indices of the digital inputs for signal I . If the signal is differential the value must be a vector with two elements where the second element specifies the input for the differential signal \bar{I} . For single-ended inputs the value must be a scalar or a vector with one or two elements. The second element is ignored in the latter case. The parameter value is ignored if the index input is disabled.

Resolver In

Purpose

Generates an exciter voltage and calculates the rotation angle or speed based on sine- and cosine-modulated feedback signals.

Description



The Resolver In input of the RT Box 2 and 3 is intended to be connected to a physical two-pole transmitter resolver. The input connects to an AD2S1210 resolver-to-digital converter from Analog Devices, Inc. The Resolver In connector on the RT Box provides a differential, sinusoidal exciter voltage with variable frequency and amplitude on the +EXC and -EXC pins. The differential feedback pins, +SIN, -SIN, +COS and -COS take amplitude modulated feedback signals from the physical resolver. The ratio of the input signals allows to calculate the angle (in rad) or speed (in rad/s) of the resolver. The Resolver In block configures the AD2S1210 converter.

The input voltages applied to the +SIN, -SIN, +COS and -COS input pins are required to be in the range of $2.3 V_{pp}$ to $4.4 V_{pp}$. Each voltage referred to ground must be in the range of 0.15 V to 4.8 V.

The RT Box 2 provides one resolver input, the RT Box 3 provides two of them. There is no resolver input available on the RT Box 1.

The minimum readout time for one resolver is around $2 \mu s$. This time is doubled when both resolver inputs of an RT Box 3 are active. If the model step size is smaller than the resolver readout time, a value of 1 at the output **v** signals the arrival of valid data.

The settling time and the maximum tracking speed are resolution dependent:

Resolution	Maximum tracking speed	Settling time 10° step	Rec. exciter frequency
10 bit	$5000 \pi/s$	0.6 ms	10 - 20 kHz
12 bit	$2000 \pi/s$	2.2 ms	6 - 20 kHz
14 bit	$1000 \pi/s$	6.5 ms	3 - 12 kHz
16 bit	$250 \pi/s$	27.5 ms	2 - 10 kHz

The output **e** signals the error state of the resolver. It consists of 8 bit where each bit indicates a separate fault condition:

Bit	Description
D7	Sine/cosine inputs clipped
D6	Sine/cosine inputs below threshold
D5	Sine/cosine inputs overrange
D4	Sine/cosine inputs mismatch
D3	Tracking error
D2	Velocity exceeds range
D1	Phase error
D0	Configuration parity error

For more details consult the AD2S1210 datasheet, available from the Analog Devices website (<https://www.analog.com>).

Parameters

Resolver module

Specifies which resolver input to use. The second resolver input is available on the RT Box 3 only.

Measurement

Specifies if the block output is the position (in rad) or the speed (in rad/s).

Resolution

The resolver resolution can be 10, 12, 14 or 16 bit. The resolution influences the maximum tracking speed and the settling time (see table above).

Exciter frequency

The frequency of the exciter output voltage (see table above for recommended settings).

Exciter voltage

The amplitude (measured peak-to-peak) for the exciter voltage. The exciter voltage should be chosen depending on the attenuation of the connected resolver such that the SIN and COS feedback voltages are within their allowed range.

Resolver Out

Purpose

Emulates a two-pole transmitter resolver by modulating the amplitude of an external exciter voltage.

Description

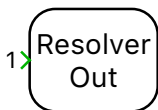

The Resolver Out block emulates a two-pole transmitter resolver. A differential exciter voltage is fed into the RT Box and multiplied by the sine and cosine of the angle signal at the block's input terminal. The angle is measured in rad. The resulting output voltages are available as differential signals on the +COS, -COS, +SIN and -SIN pins at the **Resolver Out** connector. A common DC offset can be added to the differential output signals to adjust the voltage range for resolver-to-digital converter that only allow positive input voltages (as, for example, the AD2S1210 used for the Resolver In (see page 82) in the RT Box 2 and 3).

The RT Box 2 provides one resolver output, the RT Box 3 provides two of them. There is no resolver output available on the RT Box 1.

Parameters

Resolver module

Specifies which resolver output to use. The second resolver input is available on the RT Box 3 only.

Gain

The exciter voltage may be attenuated by the given factor in addition to the sine/cosine attenuation. The maximum resolver resolution is achieved with a gain of 1.

DC output offset

Specifies an additional offset voltage to be applied to the +COS, -COS, +SIN and -SIN output signals. The value is specified in Volt.

Interpolation

If interpolation is enabled, the +COS, -COS, +SIN and -SIN output signals are generated in smaller interpolated steps between simulation steps of the RT Box. If an FPGA simulation is running, the interpolation step size is identical to the FPGA simulation step size. If no FPGA simulation is running, the interpolation step size is automatically selected as the minimum integer fraction of the CPU discretization time that is supported by the RT Box.

SFP In

Purpose

Receives signals from another RT Box

Description



For distributed models, the SFP In block receives signals from an SFP Out block (see page 86) on a remote RT Box. In each simulation step the block provides the last values received by SFP in the previous simulation step. The parameter **Initial value** specifies which signal values to output when no valid values have been received by SFP yet.

See “Distributed Realtime Simulation” on page 39 for a detailed discussion of SFP communication.

Parameters

SFP port

The name of the SFP port which is connected to the remote RT Box.

Width

The width of the incoming signal. This parameter must match the width of the signal that is connected to the corresponding SFP Out block on the remote RT Box.

Initial value

The output value of the block before a valid signal has been received from the remote RT Box.

Sample time (offline only)

For offline simulation the incoming signal is delayed by one sample to match the realtime behavior.

SFP Out

Purpose Sends signals to another RT Box

Description



For distributed models, the SFP Out block sends the signals at its input terminal to an SFP In block (see page 85) on a remote RT Box. The data transfer takes place in the subsequent simulation step. The number of signals to send is calculated from the width of the incoming signal.

Parameters

SFP port

The name of the SFP port which is connected to the remote RT Box.

Sample time (offline only)

For offline simulation the outgoing signal is delayed by one sample to match the realtime behavior.

SPI Controller

Purpose

Implement SPI communication via digital outputs/inputs.

SPI enables synchronous communication with peripheral devices. The SPI Controller block provides a clock signal which generates a configurable number of clock pulses. Data is read and written on the edges of the clock signal. For high-speed communication, the clock output signal can be looped back to an input to provide a clock input signal which is synchronized to the input data.

Description

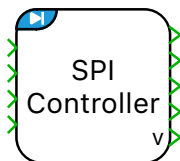

The RT Box contains two independent SPI modules that can be configured either as an SPI controller or SPI peripheral. When acting as an SPI controller the module provides a single clock and a single chip select signal. The chip select signal is held low during the data transfer. Each SPI module can receive and transmit data on up to four data lines in parallel.

An output value of 1 at the **v** port indicates that the appropriate number of clock edges has been detected on the feedback clock input and valid data is present on the other output ports. If the number of detected clock edges does not match the output value at the **v** port is set to 0 and the data output ports are not updated, i.e. they retain their values from the previous simulation step. If the skew-matched clock input is disabled, the output of the **v** port is always 1.

The RT Box contains two independent SPI units. Each unit may be used as SPI Controller or SPI Peripheral.

Parameters

Setup

SPI clock frequency [Hz]

Clock frequency used for data transmission [20e3 ... 40e6]. Each clock phase is rounded to the nearest integer multiple of 4ns.

Delay first clock pulse after CS active [ticks]

Number of SPI clock periods between CS edge and first clock edge.

Hold CS active after last clock pulse [ticks]

Number of SPI clock periods between last clock edge and CS edge.

Delay CS after simulation step

Defines the begin of the SPI transmission within a simulation step. If “Minimum” is selected the transmission starts immediately when data is available to minimize the output data latency. For “Maximum” the transmission delay is computed to minimize the input data latency. “Specify delay time” is used to adjust the delay manually.

CS delay time [s]

Time for manual delay.

Mode [CPOL, CPHA]

SPI mode as a combination of clock polarity (CPOL) and clock phase (CPHA). CPOL controls whether the clock signal is high (1) or low (0) when idle. CPHA controls whether data is shifted in and out on the rising or falling edge of the clock signal. The following table summarizes the combination of clock polarity and phase:

SPI Modes

Mode	CPOL	CPHA	Output Edge	Data Capture
SPI_MODE0	0	0	Falling	Rising
SPI_MODE1	0	1	Rising	Falling
SPI_MODE2	1	0	Rising	Falling
SPI_MODE3	1	1	Falling	Rising

Bits per word

Length of a single data word during transmission. Depending on this setting the input signals are interpreted as either uint8 or uint16.

Bit order

Defines if LSB or the MSB is transmitted and received first.

Skew-matched clock input

Enables the clock input for clock feedback. Typically required if the signal delay from the controller output to its input exceeds half a SPI clock period. If it exceeds a full period the parameter “Hold CS active after last clock pulse [ticks]” should also be increased.

Number of parallel data channels

Specifies how many of the four available data channels are used.

Words per transmission (up to 127)

Configures number of transmitted data words in each simulation step.

Sample time

The sample time determines how often data is sent (and received) on the SPI bus. It can be set to an integer multiple of the base step size. Use 0 to transfer data in every simulation step and -1 to inherit the sample time from the blocks feeding data into the SPI block.

Input

Digital input channel for skew-matched SPI clock

Clock input for clock feedback.

Digital input channel(s) for SPI data

Data input (MISO) channel/s as a scalar or vector. The width of this parameter corresponds to “Number of parallel data channels”. “-1” denotes an unused input.

Output

Digital output channel for SPI clock

Clock output channel.

Digital output channel for CS

Chip select output channel.

Digital output channel(s) for SPI data

Data output (MOSI) channel/s as a scalar or vector. The width of this parameter corresponds to “Number of parallel data channels”. “-1” denotes an unused output.

SPI Peripheral

Purpose

Implement SPI communication via digital outputs/inputs.

SPI enables synchronous communication with peripheral devices. Data is read and written on the edges of the clock signal while the chip select input is low. For high-speed communication, the internally processed clock signal, which is synchronized to the output data, can be provided on an output.

Description

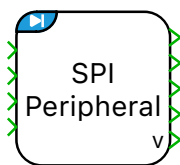

The RT Box contains two independent SPI modules that can be configured either as an SPI controller or SPI peripheral. When acting as an SPI peripheral the module provides a single clock input and a single chip select input. The chip select signal must be set to low during the data transfer.

Each SPI module can receive and transmit data on up to four data lines in parallel.

The operation of the SPI peripheral is not synchronized with the simulation. A new SPI cycle is started with the falling edge of the chip select input signal. During the SPI cycle, the device sends the data that was last received at its model inputs. To ensure data integrity, once the SPI cycle is started, the send data cannot be changed by the simulation model until the SPI cycle is complete. After the SPI cycle is complete and the correct number of clock pulses have been received, the received data from the SPI bus will be available at the model outputs of the block in the next simulation step. The availability of new data is indicated by a 1 at the **v** connector. As long as no new data is received on the SPI bus, the previously received data is available at the model outputs of the block.

The RT Box contains two independent SPI units. Each unit may be used as SPI Controller or SPI Peripheral.

Parameters

Setup

SPI clock frequency (approx) [Hz]

The approximate frequency of the SPI clock. This value is used for an internal error correction

Mode [CPOL, CPHA]

SPI mode as a combination of clock polarity (CPOL) and clock phase (CPHA). CPOL controls whether the clock signal is high (1) or low (0) when idle. CPHA controls whether data is shifted in and out on the rising or

falling edge of the clock signal. The following table summarizes the combination of clock polarity and phase:

SPI Modes

Mode	CPOL	CPHA	Output Edge	Data Capture
SPI_MODE0	0	0	Falling	Rising
SPI_MODE1	0	1	Rising	Falling
SPI_MODE2	1	0	Rising	Falling
SPI_MODE3	1	1	Falling	Rising

Bits per word

Length of a single data word during transmission. Depending on this setting the input signals are interpreted as either uint8 or uint16.

Bit order

Defines if LSB or the MSB is transmitted and received first.

Skew-matched clock output

Enables a feedback clock output, typically required for SPI frequencies above 5 MHz if the connected SPI controller provides an input for a feedback clock. The feedback clock is synchronized with the data output signals.

Number of parallel data channels

Specifies how many of the four available data channels are used.

Words per transmission (up to 127)

Configures number of transmitted data words in each simulation step.

Sample time

The sample time determines how often the SPI data is updated. It can be set to an integer multiple of the base step size. Use 0 to transfer data in every simulation step and -1 to inherit the sample time from the blocks feeding data into the SPI block.

Input

Digital input channel for SPI clock

SPI clock input.

Digital input channel for CS

Chip select input channel.

Digital input channel(s) for SPI data

Data input (MOSI) channel/s as a scalar or vector. The width of this parameter corresponds to “Number of parallel data channels”. “-1” denotes an unused input.

Output

Digital output channel for skew-matched SPI clock

SPI feedback clock output channel.

Digital output channel(s) for SPI data

Data output (MISO) channel/s as a scalar or vector. The width of this parameter corresponds to “Number of parallel data channels”. “-1” denotes an unused output.

To File

Purpose

Write signal values to a file.

Description

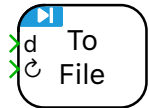

While a simulation on the RT Box is running the To File block continuously writes the values of its input signals to a file. The data is written in single precision format. The file format can be either a text file with comma separated values (csv) or a MATLAB data file (mat).

To ensure consistent data the simulation must be stopped before retrieving the data file.

On the RT Box 1 and CE files can only be stored on an external USB flash drive. On the RT Box 2 and 3 files can be stored on the internal SSD or an external USB flash drive. For high data throughput a USB 3.0 device should be used. Removing a USB flash drive during the write process may result in inconsistent files, especially if the MATLAB format (mat) is selected.

To retrieve files from the internal SSD or an external USB flash drive, establish a WebDAV connection to `http://<rtbox name>/dav`. On Windows and Mac OS this can be done from the operating system directly. As an alternative, a web interface is available at `http://<rtbox name>/dav`. (Replace `<rtbox name>` with the hostname of your rtbox, e.g. `rtbox-20b0f70361c2.local`.)

Parameters

Filename

The name of the data file to write to. Files are stored in a new directory named after the model currently executed on the RT Box, with four digit number appended. The appended number is increased automatically on each simulation run. A file named `latest.txt` is created containing the newest directory name. The file is overwritten each time a simulation is started if it already exists.

The maximum file size is limited to 2 GB. If the file size is exceeded, a new file with an increasing number appended is created automatically. File rotation may lead to data loss.

If the option **literal** is chosen, the string that is entered is taken literally as the basename of the data file. A suffix `.csv` or `.mat` is added depending on the file type. If the option **evaluate** is chosen, the string that is entered is interpreted as a MATLAB/Octave expression that must yield a string, which in turn is taken as the basename of the data file. If, for example, the value `['MyFile' num2str(index)]` is entered and the current workspace contains a variable `index` with a value of 2, the file name will be `MyFile2.csv` or `MyFile2.mat`.

File Type

The file format to use for the data file. The file can be written as a text file with comma separated values (csv) or as a MATLAB data file (mat). Writing to a MATLAB data file is significantly faster compared to a csv file. The minimum `Sample times` for different RT Box versions are given in the table below:

Minimum supported sample times for different RT Box versions

Target	.csv	.mat
RT Box 1/CE	100 μs	10 μs
RT Box 2/3	10 μs	2 μs

Data type

Selects whether the data is stored in single or double precision.

Write device

Selects whether to store files on the internal SSD (Internal SSD) or an external USB flash drive (USB Flash Drive).

Sample time

The input data will be written to the data file once in the given time period.

File rotation

If enabled, the current output file is closed and a new output file is created when a transition from a boolean **false** to a boolean **true** is detected at the rotation input port.

UDP Receive

Purpose Receives data sent as UDP packets over the network.

Description



The block opens a UDP network port with the specified port number. If a packet with the required amount of data is received on the UDP port, the data is interpreted as the specified data type and made available on the **d** block output. The output **v** is **1** in each simulation step where new data is received, **0** otherwise.

The received data is interpreted as a contiguous block of data of the specified data type with no padding. Little endian byte order is assumed for integer data types. Packets that don't have the required data size are discarded.

Parameters

Port

The UDP port to open. Ports below 1024 are reserved for system services and should not be used.

Width

The number of values that are expected in the UDP packet.

Data type

The data type of the data in the UDP packet.

UDP Send

Purpose

Sends data as UDP packets over the network.

Description

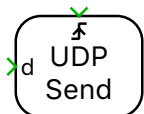

The block sends data to a network device using UDP packets. The data at the input port **d** is casted to the specified data type and packed contiguously with no padding. Little endian byte order is used for integer data types.

Data can either be sent regularly with a fixed sample time or on demand when the trigger input changes. When configured for triggered execution, packets are sent when the trigger signal changes in the manner specified by the **Trigger type** parameter:

rising

Data is sent when the trigger signal changes from 0 to a non-zero value.

falling

Data is sent when the trigger signal changes from a non-zero value to 0.

either

Data is sent when the trigger signal changes from 0 to a non-zero value or vice versa.

Parameters

Remote host name or IP address

The hostname or IP address of the remote network device where the data is sent to. The IP address must be specified as 4 bytes separated by dots, e.g. **127.0.0.1**. If a host name is specified the RT Box must have access to a name server (DNS).

Remote IP port

The port of the remote network device where the data is sent to. Ports below 1024 are reserved for system services and should not be used.

Data type

The data type of the data in the UDP packet.

Execution

Selects between **regular** and **triggered** execution.

Sample time

The time period for regular packet transmission (for regular execution only).

Trigger type

The direction of the edges of the trigger signal upon which the data is sent, as described above (for triggered execution only).

Wall Clock

Purpose

Outputs the current time and date.

Description

The Wall Clock Block allows access to the real-time clock of the RT Box. It delivers the following output signals:

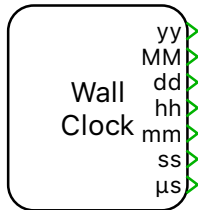

yy

Current year

MM

Current month

dd

Day of month

hh

Current hour

mm

Current minute

ss

Current second

μs

Current microsecond

The RT Box 2 and 3 contain an internal real time clock, which provides the time immediately after power-on. The clock is synchronized over the network if the RT Box can contact an NTP (Network Time Protocol) server. The RT Box 1 does not contain an internal real time clock. To get the current time, the box must contact an NTP server before the simulation is started.

To change the default NTP time server, place a file named **ntp.conf** in the directory **config/etc** of the SD card of the RT Box. The file should contain one or more lines with NTP server entries of the form

```
server servername iburst
```

where *servername* is the domain name or the IP address of the NTP server.

Parameters

Offset to UTC [h]

The offset of the local timezone to UTC (Universal Time Coordinated), in hours. The RT Box does not provide automatic adjustment to daylight saving time.

plexim
electrical engineering software
